

Precision meets Quality

**Sinus Surgery**  
Nasennebenhöhlen

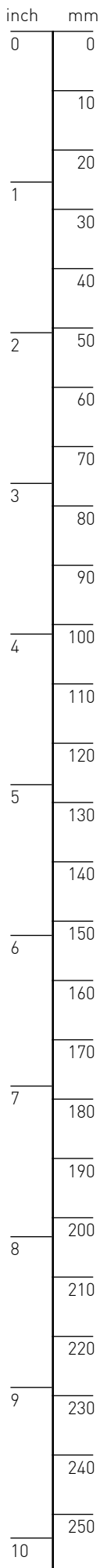

### Edition 2026

The content of this catalogue is the literary property of FENTEX medical GmbH. The reproduction, translation or partial utilization of information is not permitted without prior written authorization from FENTEX medical.

All products shown in this catalogue carry a CE mark and are certified for distribution within the appropriate markets. Please note that some international markets have special certification requirements and that restrictions may apply. Information is available from FENTEX medical upon request.

Please refer to the current version of our general terms and conditions as well as the latest price list for further information on product availability and shipment terms.

We continuously strive to improve and update our products, to always meet or excel our customer's expectations and thus reserve the right to make alterations to our products without prior notice.



**FENTEXmedical GmbH is certified according to EN ISO 13485:2016 / A11:2021 and directive 93/42/EEC.**

### Katalogausgabe 2026

Der Inhalt des vorliegenden Kataloges ist das geistige Eigentum der Firma FENTEX medical GmbH. Reproduktionen, Übersetzungen oder auch die teilweise Verwertung von Informationen hieraus sind untersagt bzw. nur nach vorheriger schriftlicher Genehmigung durch die FENTEX GmbH erlaubt.

Bei Verstößen oder Missbrauch behalten wir uns rechtliche Schritte vor. Die Produkte tragen das CE Zeichen und sind damit für dessen Geltungsbereich zugelassen. Für einzelne geografische Märkte kann eine gesonderte Registrierung bzw. Zertifizierung notwendig sein. Informationen dazu werden auf Anfrage mitgeteilt.

Darüber hinaus gelten die Allgemeinen Geschäftsbedingungen der FENTEX Medical GmbH in der jeweils gültigen Fassung, sowie die jeweils aktuelle Preisliste.

Bitte beachten Sie, dass es in Einzelfällen zu leichten Maßabweichungen kommen kann, die aber die grundlegende Funktion der Produkte nicht beeinträchtigen. Modelländerungen vorbehalten.



**FENTEXmedical GmbH ist zertifiziert nach EN ISO 13485:2016 / A11:2021 und der Richtlinie 93/42/EWG.**

### Contact Details

#### Kontaktinformationen

FENTEXmedical GmbH  
take-off GewerbePark 2  
D-78579 Neuhausen ob Eck  
Germany

Tel. +49 (0) 7467 - 949 62 0  
Fax +49 (0) 7467 - 949 62 17

info@fentexmedical.com  
www.fentexmedical.com



## Sinus Surgery Nasennebenhöhlen

### **PRECISION MEETS QUALITY**

FENTEXmedical GmbH is a medical company specializing in manufacturing and marketing of surgical instruments and endoscopy systems for ENT and Head & Neck surgeons.

Especially in this part of the human body with its anatomical and functional complexity and high aesthetic demands special skills are required. It is our mission not only to meet but to surpass these requirements with our products and services.

### **PRECISION MEETS QUALITY**

FENTEXmedical GmbH ist ein Unternehmen, das sich auf die Entwicklung, Produktion und den Vertrieb chirurgischer Instrumente und Endoskopiesysteme für die Hals- Nasen und Ohrenheilkunde spezialisiert hat.

Gerade in diesem Bereich des menschlichen Körpers sind aufgrund der anatomischen und funktionalen Komplexität sowie der hohen ästhetischen Anforderungen besondere Qualitäten gefordert. Es ist unsere Mission, diese Qualitätsanforderungen mit unseren Produkten und Dienstleistungen nicht nur zu erfüllen sondern zu übertreffen.

## Sinus Surgery Nasennebenhöhlen

### Precision

We maintain a close cooperation with all of the medical specialists involved in head & neck surgery, including ENT-, Otolaryngologists and Plastic Surgeons. This cooperation allows us to precisely adapt the instrument and match it with the requirements of a particular operational technique. It also ensures that the latest developments are being consistently incorporated into our products. Together with our superior design and finishing we help to ensure your surgical achievements.

### Präzision

Wir pflegen die enge Kooperation mit Spezialisten aller im Kopf- und Halsbereich tätigen chirurgischen Disziplinen. Dadurch können wir Ihnen für jede Indikation das passende Instrument bereitstellen und halten unser gesamtes Sortiment auf dem aktuellen Stand der medizinischen Entwicklung. Die Präzision in der Ausführung der Instrumente sichert Ihnen den Operationserfolg.

### Customer Orientation

We market our products world wide through highly qualified specialist dealers thus achieving a maximum in local customer-service and -support. Our organisation is open to suggestions from clinical users and demand for custom made devices.

### Kundenorientierung

Wir vertreiben unsere Produkte weltweit durch ein fachlich versiertes Händlernetz und erreichen dadurch ein Maximum in der Kundenbetreuung vor Ort. Darüber hinaus sind wir auch jederzeit ansprechbar im Hinblick auf die Sonderwünsche unserer Kunden.



**728500FX** **Hi-View Telescope**, autoclavable, 0°, WL 110 mm, Ø 2.7 mm  
**Hi-View Optik**, autoklavierbar, 0°, NL 110 mm, Ø 2,7 mm

<b>728500FX</b>	autoclavable / 0°, WL 110 mm, Ø 2.7 mm	autoklavierbar / 0°, NL 110 mm, Ø 2,7 mm
<b>728530FX</b>	autoclavable / 30°, WL 110 mm, Ø 2.7 mm	autoklavierbar / 30°, NL 110 mm, Ø 2,7 mm
<b>728570FX</b>	autoclavable / 70°, WL 110 mm, Ø 2.7 mm	autoklavierbar / 70°, NL 110 mm, Ø 2,7 mm



**728200FX** **Hi-View Telescope**, autoclavable, 0°, WL 140 mm, Ø 2.7 mm  
**Hi-View Optik**, autoklavierbar, 0°, NL 140 mm, Ø 2,7 mm

<b>728200FX</b>	autoclavable / 0°, WL 140 mm, Ø 2.7 mm	autoklavierbar / 0°, NL 140 mm, Ø 2,7 mm
<b>728230FX</b>	autoclavable / 30°, WL 140 mm, Ø 2.7 mm	autoklavierbar / 30°, NL 140 mm, Ø 2,7 mm
<b>728270FX</b>	autoclavable / 70°, WL 140 mm, Ø 2.7 mm	autoklavierbar / 70°, NL 140 mm, Ø 2,7 mm



**728100FX** **Hi-View Telescope**, autoclavable, 0°, WL 195 mm, Ø 2.7 mm  
**Hi-View Optik**, autoklavierbar, 0°, NL 195 mm, Ø 2,7 mm

<b>728100FX</b>	autoclavable / 0°, WL 195 mm, Ø 2.7 mm	autoklavierbar / 0°, NL 195 mm, Ø 2,7 mm
<b>728130FX</b>	autoclavable / 30°, WL 195 mm, Ø 2.7 mm	autoklavierbar / 30°, NL 195 mm, Ø 2,7 mm
<b>728170FX</b>	autoclavable / 70°, WL 195 mm, Ø 2.7 mm	autoklavierbar / 70°, NL 195 mm, Ø 2,7 mm



**730100FX** **Hi-View Telescope**, autoclavable, 0°, WL 150 mm, Ø 3 mm  
**Hi-View Optik**, autoklavierbar, 0°, NL 150 mm, Ø 3 mm

<b>730100FX</b>	autoclavable / 0°, WL 150 mm, Ø 3 mm	autoklavierbar / 0°, NL 150 mm, Ø 3 mm
<b>730130FX</b>	autoclavable / 30°, WL 150 mm, Ø 3 mm	autoklavierbar / 30°, NL 150 mm, Ø 3 mm
<b>730145FX</b>	autoclavable / 45°, WL 150 mm, Ø 3 mm	autoklavierbar / 45°, NL 150 mm, Ø 3 mm



**750100FX** **Hi-View Telescope**, autoclavable, 0°, WL 185 mm, Ø 4 mm  
**Hi-View Optik**, autoklavierbar, 0°, NL 185 mm, Ø 4 mm

<b>750100FX</b>	autoclavable / 0°, WL 185 mm, Ø 4 mm	autoklavierbar / 0°, NL 185 mm, Ø 4 mm
<b>750130FX</b>	autoclavable / 30°, WL 185 mm, Ø 4 mm	autoklavierbar / 30°, NL 185 mm, Ø 4 mm
<b>750145FX</b>	autoclavable / 45°, WL 185 mm, Ø 4 mm	autoklavierbar / 45°, NL 185 mm, Ø 4 mm
<b>750170FX</b>	autoclavable / 70°, WL 185 mm, Ø 4 mm	autoklavierbar / 70°, NL 185 mm, Ø 4 mm



**741200FX**    **Protection Tube**, for Telescopes  
**Schutzhülse**, für Optiken



**863100FX**



**863110FX**



**863101FX**

**863100FX**    **Antifog solution „ULTRA STOP“**, pipette bottle, 25 ml  
**Antibeschlagmittel „ULTRA STOP“**, Pipettenflasche, 25 ml

**863110FX**    **Antifog solution „ULTRA STOP“**, spray bottle, 15 ml  
**Antibeschlagmittel „ULTRA STOP“**, Sprühflasche, 15 ml

**863101FX**    **Antifog solution „ULTRA STOP“**, injection vial, sterile, 30 ml  
**Antibeschlagmittel „ULTRA STOP“**, Durchstechflasche, steril, 30 ml

**Sinus Surgery**  
**Nasennebenhöhlen**



**418500FX**

**418500FX** **Sinuscopy Trocar**, beak-shaped distal tip, for 4 mm scopes, Ø 5 mm, length of cannula 8.5 cm  
**Sinuskopie-Trokar**, Ende schnabelförmig, für 4 mm Optiken, Ø 5 mm, Länge Trokarhülse 8,5 cm



**418600FX**

**418600FX** **Sinuscopy Trocar**, oblique distal tip, for 4 mm scopes, Ø 5 mm, length of cannula 8.5 cm  
**Sinuskopie-Trokar**, Ende schräg, für 4 mm Optiken, Ø 5 mm, Länge Trokarhülse 8,5 cm

**418600FX** oblique distal tip, for 4 mm scopes / Ø 5 mm, length of cannula 8.5 cm  
 Ende schräg, für 4 mm Optiken / Ø 5 mm, Länge Trokarhülse 8,5 cm

**418603FX** oblique distal tip, for 2.7 mm scopes / Ø 3.3 mm, length of cannula 7.5 cm  
 Ende schräg, für 2,7 mm Optiken / Ø 3,3 mm, Länge Trokarhülse 7,5 cm

**418604FX** oblique distal tip, for 3 mm scopes / Ø 4 mm, length of cannula 7.5 cm  
 Ende schräg, für 3 mm Optiken / Ø 4 mm, Länge Trokarhülse 7,5 cm



**049415FX** **Antrum Trocar Needle by Lichtwitz**, WL 10 cm, Ø 1.5 mm  
**Kieferhöhlenpunktionsnadel n. Lichtwitz**, NL 10 cm, Ø 1,5 mm

**049415FX** WL 10 cm, Ø 1.5 mm NL 10 cm, Ø 1,5 mm

**049418FX** WL 10 cm, Ø 1.8 mm NL 10 cm, Ø 1,8 mm

**049420FX** WL 10 cm, Ø 2 mm NL 10 cm, Ø 2 mm



**032416FX** **Ear Dressing Forceps by Jansen**, bayonet-shaped, 16 cm  
**Ohrpinzette nach Jansen**, bajonettförmig, 16 cm



**049702FX** **Antrum Cannula by Van Eicken**, long curved, Luer-Lock, 15 cm, Ø 2.5 mm  
**Spülröhrchen nach Van Eicken**, lang gebogen, Luer-Lock, 15 cm, Ø 2,5 mm

<b>049702FX</b>	long curved, Luer-Lock / 15 cm, Ø 2.5 mm	lang gebogen, Luer-Lock / 15 cm, Ø 2,5 mm
<b>049703FX</b>	long curved, Luer-Lock / 15 cm, Ø 3 mm	lang gebogen, Luer-Lock / 15 cm, Ø 3 mm
<b>049704FX</b>	long curved, Luer-Lock / 15 cm, Ø 4 mm	lang gebogen, Luer-Lock / 15 cm, Ø 4 mm



**049712FX** **Antrum Cannula by Van Eicken**, short curved, Luer-Lock, 15 cm, Ø 2.5 mm  
**Spülröhrchen nach Van Eicken**, kurz gebogen, Luer-Lock, 15 cm, Ø 2,5 mm

<b>049712FX</b>	short curved, Luer-Lock / 15 cm, Ø 2.5 mm	kurz gebogen, Luer-Lock / 15 cm, Ø 2,5 mm
<b>049713FX</b>	short curved, Luer-Lock / 15 cm, Ø 3 mm	kurz gebogen, Luer-Lock / 15 cm, Ø 3 mm
<b>049714FX</b>	short curved, Luer-Lock / 15 cm, Ø 4 mm	kurz gebogen, Luer-Lock / 15 cm, Ø 4 mm



**049802FX** **Antrum Cannula by Van Eicken**, long curved, Luer-Lock, malleable, 15 cm, Ø 2.5 mm  
**Spülröhrchen nach Van Eicken**, lang gebogen, Luer-Lock, biegsam, 15 cm, Ø 2,5 mm

<b>049802FX</b>	long curved, Luer-Lock, malleable / 15 cm, Ø 2.5 mm	lang gebogen, Luer-Lock, biegsam / 15 cm, Ø 2,5 mm
<b>049803FX</b>	long curved, Luer-Lock, malleable / 15 cm, Ø 3 mm	lang gebogen, Luer-Lock, biegsam / 15 cm, Ø 3 mm
<b>049804FX</b>	long curved, Luer-Lock, malleable / 15 cm, Ø 4 mm	lang gebogen, Luer-Lock, biegsam / 15 cm, Ø 4 mm



**110106FX** **Suction Tube by Frazier**, straight tip, with cut-off hole, WL 10 cm, 6 Fr.  
**Saugrohr nach Frazier**, gerades Ende, mit Unterbrecherloch, NL 10 cm, 6 Charr.

<b>110106FX</b>	straight tip, with cut-off hole / WL 10 cm, 6 Fr.	gerades Ende, mit Unterbrecherloch / NL 10 cm, 6 Charr.
<b>110107FX</b>	straight tip, with cut-off hole / WL 10 cm, 7 Fr.	gerades Ende, mit Unterbrecherloch / NL 10 cm, 7 Charr.
<b>110108FX</b>	straight tip, with cut-off hole / WL 10 cm, 8 Fr.	gerades Ende, mit Unterbrecherloch / NL 10 cm, 8 Charr.
<b>110109FX</b>	straight tip, with cut-off hole / WL 10 cm, 9 Fr.	gerades Ende, mit Unterbrecherloch / NL 10 cm, 9 Charr.
<b>110110FX</b>	straight tip, with cut-off hole / WL 10 cm, 10 Fr.	gerades Ende, mit Unterbrecherloch / NL 10 cm, 10 Charr.
<b>110112FX</b>	straight tip, with cut-off hole / WL 10 cm, 12 Fr.	gerades Ende, mit Unterbrecherloch / NL 10 cm, 12 Charr.
<b>110115FX</b>	straight tip, with cut-off hole / WL 10 cm, 15 Fr.	gerades Ende, mit Unterbrecherloch / NL 10 cm, 15 Charr.



**110116FX** **Suction Tube by Frazier**, ball point tip, with cut-off hole, WL 10 cm, 6 Fr.  
**Saugrohr nach Frazier**, olivenförmiges Ende, mit Unterbrecherloch, NL 10 cm, 6 Charr.

<b>110116FX</b>	ball point tip, with cut-off hole / WL 10 cm, 6 Fr.	olivenförmiges Ende, mit Unterbrecherloch / NL 10 cm, 6 Charr.
<b>110118FX</b>	ball point tip, with cut-off hole / WL 10 cm, 8 Fr.	olivenförmiges Ende, mit Unterbrecherloch / NL 10 cm, 8 Charr.
<b>110120FX</b>	ball point tip, with cut-off hole / WL 10 cm, 10 Fr.	olivenförmiges Ende, mit Unterbrecherloch / NL 10 cm, 10 Charr.
<b>110122FX</b>	ball point tip, with cut-off hole / WL 10 cm, 12 Fr.	olivenförmiges Ende, mit Unterbrecherloch / NL 10 cm, 12 Charr.
<b>110125FX</b>	ball point tip, with cut-off hole / WL 10 cm, 15 Fr.	olivenförmiges Ende, mit Unterbrecherloch / NL 10 cm, 15 Charr.



**111106FX** **Suction Tube by Frazier**, with graduation, with cut-off hole, WL 10 cm, 6 Fr.  
**Saugrohr nach Frazier**, mit Graduierung, mit Unterbrecherloch, NL 10 cm, 6 Charr.

<b>111106FX</b>	with graduation, with cut-off hole / WL 10 cm, 6 Fr.	mit Graduierung, mit Unterbrecherloch / NL 10 cm, 6 Charr.
<b>111107FX</b>	with graduation, with cut-off hole / WL 10 cm, 7 Fr.	mit Graduierung, mit Unterbrecherloch / NL 10 cm, 7 Charr.
<b>111108FX</b>	with graduation, with cut-off hole / WL 10 cm, 8 Fr.	mit Graduierung, mit Unterbrecherloch / NL 10 cm, 8 Charr.
<b>111109FX</b>	with graduation, with cut-off hole / WL 10 cm, 9 Fr.	mit Graduierung, mit Unterbrecherloch / NL 10 cm, 9 Charr.
<b>111110FX</b>	with graduation, with cut-off hole / WL 10 cm, 10 Fr.	mit Graduierung, mit Unterbrecherloch / NL 10 cm, 10 Charr.
<b>111112FX</b>	with graduation, with cut-off hole / WL 10 cm, 12 Fr.	mit Graduierung, mit Unterbrecherloch / NL 10 cm, 12 Charr.
<b>111115FX</b>	with graduation, with cut-off hole / WL 10 cm, 15 Fr.	mit Graduierung, mit Unterbrecherloch / NL 10 cm, 15 Charr.

**Sinus Surgery**  
**Nasennebenhöhlen**

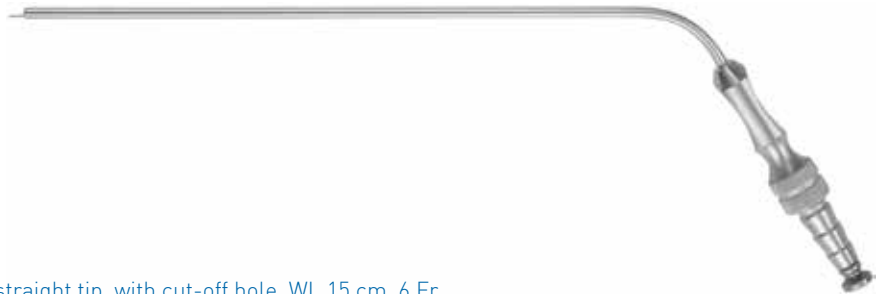

**250106FX** **Suction Tube by Frazier**, straight tip, with cut-off hole, WL 15 cm, 6 Fr.  
**Saugkanüle nach Frazier**, gerades Ende, mit Unterbrecherloch, NL 15 cm, 6 Charr.

<b>250106FX</b>	straight tip, with cut-off hole / WL 15 cm, 6 Fr.	gerades Ende, mit Unterbrecherloch / NL 15 cm, 6 Charr.
<b>250108FX</b>	straight tip, with cut-off hole / WL 15 cm, 8 Fr.	gerades Ende, mit Unterbrecherloch / NL 15 cm, 8 Charr.
<b>250110FX</b>	straight tip, with cut-off hole / WL 15 cm, 10 Fr.	gerades Ende, mit Unterbrecherloch / NL 15 cm, 10 Charr.
<b>250112FX</b>	straight tip, with cut-off hole / WL 15 cm, 12 Fr.	gerades Ende, mit Unterbrecherloch / NL 15 cm, 12 Charr.
<b>250115FX</b>	straight tip, with cut-off hole / WL 15 cm, 15 Fr.	gerades Ende, mit Unterbrecherloch / NL 15 cm, 15 Charr.



**111710FX** **Suction Tube by Kahn-Frazier**, slightly curved, malleable shaft, WL 15 cm, 10 Fr.  
**Saugrohr nach Kahn-Frazier**, leicht gebogen, biegsamer Schaft, NL 15 cm, 10 Charr.

**111810FX** **Suction Tube by Kahn-Frazier**, strongly curved, malleable shaft, WL 15 cm, 10 Fr.  
**Saugrohr nach Kahn-Frazier**, stark gebogen, biegsamer Schaft, NL 15 cm, 10 Charr.



**250220FX** **Suction Tube by Frank-Pasquini**, tip curved upwards, ball end, WL 13 cm, Ø 3 mm  
**Saugrohr nach Frank-Pasquini**, Spitze aufwärts gebogen, kugelförmiges E, NL 13 cm, Ø 3 mm



**250221FX** **Suction Tube by Frank-Pasquini**, tip curved downwards, ball end, WL 13 cm, Ø 3 mm  
**Saugrohr nach Frank-Pasquini**, Spitze abwärts gebogen, kugelförmiges En, NL 13 cm, Ø 3 mm

**Sinus Surgery**  
**Nasennebenhöhlen**



**730116FX** **Bipolar Forceps**, straight, with guiding pin, 16 cm, tip 0.5 mm  
**Bipolare Pinzette**, gerade, mit Führungsstift, 16 cm, Spitze 0,5 mm



**730116FX**      **730119FX**      **731116FX**      **731119FX**      **732116FX**      **732119FX**

<b>730116FX</b>	straight, with guiding pin / 16 cm, tip 0.5 mm	gerade, mit Führungsstift / 16 cm, Spitze 0,5 mm
<b>730119FX</b>	straight, with guiding pin / 19.5 cm, tip 0.5 mm	gerade, mit Führungsstift / 19,5 cm, Spitze 0,5 mm
<b>731116FX</b>	straight, with guiding pin / 16 cm, tip 1 mm	gerade, mit Führungsstift / 16 cm, Spitze 1 mm
<b>731119FX</b>	straight, with guiding pin / 19.5 cm, tip 1 mm	gerade, mit Führungsstift / 19,5 cm, Spitze 1 mm
<b>732116FX</b>	straight, with guiding pin / 16 cm, tip 2 mm	gerade, mit Führungsstift / 16 cm, Spitze 2 mm
<b>732119FX</b>	straight, with guiding pin / 19.5 cm, tip 2 mm	gerade, mit Führungsstift / 19,5 cm, Spitze 2 mm



**741116FX** **Bipolar Forceps**, angled, with guiding pin, 16 cm, tip 1 mm  
**Bipolare Pinzette**, abgewinkelt, mit Führungsstift, 16 cm, Spitze 1 mm



**741116FX**      **741119FX**      **742116FX**      **742119FX**

<b>741116FX</b>	angled, with guiding pin / 16 cm, tip 1 mm	abgewinkelt, mit Führungsstift / 16 cm, Spitze 1 mm
<b>741119FX</b>	angled, with guiding pin / 19.5 cm, tip 1 mm	abgewinkelt, mit Führungsstift / 19,5 cm, Spitze 1 mm
<b>742116FX</b>	angled, with guiding pin / 16 cm, tip 2 mm	abgewinkelt, mit Führungsstift / 16 cm, Spitze 2 mm
<b>742119FX</b>	angled, with guiding pin / 19.5 cm, tip 2 mm	abgewinkelt, mit Führungsstift / 19,5 cm, Spitze 2 mm



**761116FX** **Bipolar Forceps**, bayonet, with guiding pin, 16.5 cm, straight tip 1 mm  
**Bipolare Pinzette**, bajonett, mit Führungsstift, 16,5 cm, gerade Spitze 1 mm



**761116FX**

**761119FX**

**762119FX**

<b>761116FX</b>	bayonet, with guiding pin / 16.5 cm, straight tip 1 mm	bajonett, mit Führungsstift / 16,5 cm, gerade Spitze 1 mm
<b>761119FX</b>	bayonet, with guiding pin / 19 cm, straight tip 1 mm	bajonett, mit Führungsstift / 19 cm, gerade Spitze 1 mm
<b>762119FX</b>	bayonet, with guiding pin / 19 cm, straight tip 2 mm	bajonett, mit Führungsstift / 19 cm, gerade Spitze 2 mm



**750861FX** **Bipolar Forceps**, angular, with suction, 19 cm, tip 2 mm  
**Bipolare Pinzette**, kniegebogen, mit Saugung, 19 cm, Spitze 2 mm

**Sinus Surgery**  
**Nasennebenhöhlen**



**726504FX** **Bipolar Cable**, for ERBE, Storz, Wolf units, 4.5 m  
**Bipolares HF Kabel**, für ERBE, Storz, Wolf Generatoren, 4,5 m



**726506FX** **Bipolar Cable**, for US Standard + ERBE ICC units, 4.5 m  
**Bipolares HF Kabel**, für US Standard + ERBE ICC Generatoren, 4,5 m



**726508FX** **Bipolar Cable**, for Martin, Berchtold, Aesculap units, 4.5 m  
**Bipolares HF Kabel**, für Martin, Berchtold, Aesculap Gen., 4,5 m



**726516FX** **Bipolar Cable**, for Valleylab, Lamidey, EMC, Bowa units, 4.5 m  
**Bipolares HF Kabel**, für Valleylab, Lamidey, EMC, Bowa Gen., 4,5 m



**201200FX** **Septum Needle**, angled, Luer-Lock, WL 10.5 cm, Ø 0.8 mm  
**Septumkanüle**, kniegebogen, Luer-Lock, NL 10,5 cm, Ø 0.8 mm

**Sinus Surgery**  
**Nasennebenhöhlen**



**215100FX** **Elevator by Freer**, double-ended, semi-sharp / blunt, 19 cm  
**Doppelelevatorium nach Freer**, halbscharf / stumpf, 19 cm



**215200FX** **Elevator by Freer**, double-ended, sharp / blunt, 18 cm  
**Doppelelevatorium nach Freer**, scharf / stumpf, 18 cm



**215215FX** **Elevator by Weiss**, double-ended, blunt / blunt  
**Doppelelevatorium nach Weiss**, stumpf / stumpf



**305100FX** **Elevator by Masing**, double-ended, sharp / blunt, graduated, 21.5 cm  
**Doppelelevatorium nach Masing**, scharf / stumpf, graduiert, 21,5 cm



**305900FX** **Suction Elevator by Gorney**, with Mandrin, 21.5 cm  
**Saugelevatorium nach Gorney**, mit Mandrin, 21,5 cm



**360100FX**

**360100FX** **Suction Elevator by Guillen**, straight tip, 20 cm  
**Saugelevatorium nach Guillen**, Spitze gerade, 20 cm



**418719FX** **Maxillary Sinus Seeker**, double-ended, ball ends, 19 cm, Ø 1.2 mm and 2 mm  
**Kieferhöhlensonde**, doppelendig, kugelförmige Enden, 19 cm, Ø 1,2 mm und 2 mm



**418825FX** **Frontal Sinus Seeker by Castelnovo**, double-ended, curved, 21 cm  
**Stirnhöhlensonde nach Castelnovo**, doppelendig, gebogen, 21 cm

**Sinus Surgery**  
**Nasennebenhöhlen**



**418826FX** **Frontal Sinus Seeker by Kuhn**, double-ended, both sides curved 90°, 19 cm, Fig. 2  
**Stirnhöhlensonde nach Kuhn**, doppelendig, beide Seiten 90° gebogen, 19 cm, Fig. 2



**407125FX** **Frontal Sinus Bougie by Ritter-Halle**, 16 cm, Ø 2.5 mm  
**Stirnhöhlenbougie nach Ritter-Halle**, 16 cm, Ø 2,5 mm

<b>407125FX</b>	16 cm, Ø 2.5 mm	16 cm, Ø 2,5 mm
<b>407130FX</b>	16 cm, Ø 3 mm	16 cm, Ø 3 mm
<b>407140FX</b>	16 cm, Ø 4 mm	16 cm, Ø 4 mm
<b>407150FX</b>	16 cm, Ø 5 mm	16 cm, Ø 5 mm



**411100FX** **Chisel by West**, 18 cm, width 4 mm  
**Flachmeißel nach West**, 18 cm, Breite 4 mm



**411200FX** **Gouge by West**, 18 cm, width 4 mm  
**Hohlmeißel nach West**, 18 cm, Breite 4 mm



**418100FX** **Antrum Elevator by Sewall**, 19.5 cm  
**Kieferhöhlen-Elevatorium nach Sewall**, 19,5 cm

**Sinus Surgery**  
**Nasennebenhöhlen**



**418101FX** **Antrum Curette**, oval, 20 cm, size 1  
**Antrumlöffel**, oval, 20 cm, Fig. 1

<b>418101FX</b>	oval / 20 cm, size 1	oval / 20 cm, Fig. 1
<b>418102FX</b>	oval / 20 cm, size 2	oval / 20 cm, Fig. 2
<b>418103FX</b>	oval / 20 cm, size 3	oval / 20 cm, Fig. 3



**418201FX** **Antrum Curette**, round, small, 19 cm  
**Antrumlöffel**, rund, klein, 19 cm



**418202FX** **Antrum Curette**, oblong, small, 19 cm  
**Antrumlöffel**, längsoval, klein, 19 cm



**418203FX** **Antrum Curette**, oblong, large, 19 cm  
**Antrumlöffel**, längsoval, groß, 19 cm



**418204FX**



**418204FX** **Frontal Sinus Curette**, 55° curved, oblong, 19 cm  
**Stirnhöhlenlöffel**, 55° gebogen, längsoval, 19 cm



**418205FX**



**418205FX** **Frontal Sinus Curette**, 90° curved, oblong, 18 cm  
**Stirnhöhlenlöffel**, 90° gebogen, längsoval, 18 cm

**Sinus Surgery**  
**Nasennebenhöhlen**



**404100FX** **Antrum Curette by Faulkner**, double-ended, 21 cm  
**Kieferhöhlenkürette nach Faulkner**, doppelendig, 21 cm



**406101FX** **Antrum Curette by Halle**, malleable, 21 cm, size 1  
**Kieferhöhlenlöffel nach Halle**, biegsam, 21 cm, Fig. 1

<b>406101FX</b>	malleable / 21 cm, size 1	biegsam / 21 cm, Fig. 1
<b>406102FX</b>	malleable / 21 cm, size 2	biegsam / 21 cm, Fig. 2
<b>406103FX</b>	malleable / 21 cm, size 3	biegsam / 21 cm, Fig. 3



**418303FX** **Antrum Curette**, small, forward cutting, 19 cm  
**Antrum-Kürette**, klein, vorwärts schneidend, 19 cm



**418304FX** **Antrum Curette**, small, backward cutting, 19 cm  
**Antrum-Kürette**, klein, rückwärts schneidend, 19 cm

**Sinus Surgery**  
**Nasennebenhöhlen**



**403101FX** **Antrum Curette by Coakley**, 18 cm, size 1  
**Kieferhöhlenkürette nach Coakley**, 18 cm, Fig. 1



**403102FX** **Antrum Curette by Coakley**, 18 cm, size 2  
**Kieferhöhlenkürette nach Coakley**, 18 cm, Fig. 2



**403103FX** **Antrum Curette by Coakley**, 18 cm, size 3  
**Kieferhöhlenkürette nach Coakley**, 18 cm, Fig. 3



**403104FX** **Antrum Curette by Coakley**, 18 cm, size 4  
**Kieferhöhlenkürette nach Coakley**, 18 cm, Fig. 4

**Sinus Surgery**  
**Nasennebenhöhlen**



**403105FX** **Antrum Curette by Coakley**, 18 cm, size 5  
**Kieferhöhlenkürette nach Coakley**, 18 cm, Fig. 5



**403106FX**



**403106FX** **Antrum Curette by Coakley**, 18 cm, size 6  
**Kieferhöhlenkürette nach Coakley**, 18 cm, Fig. 6



**418401FX** **Sickle Knife**, pointed, 19 cm  
**Sichelmesser**, spitz, 19 cm

<b>418401FX</b>	pointed / 19 cm	spitz / 19 cm
<b>418402FX</b>	round / 19 cm	abgerundet / 19 cm
<b>418403FX</b>	pointed, curved left / 19 cm	spitz, links gebogen / 19 cm
<b>418404FX</b>	pointed, curved right / 19 cm	spitz, rechts gebogen / 19 cm



**153700FX** **Sickle Knife by Plester**, curved, 16.5 cm  
**Sichelmesser nach Plester**, gebogen, 16,5 cm



**226300FX** **Nasal Scissors**, straight, serrated, WL 13 cm  
**Nasenschere**, gerade, gezahnt, NL 13 cm

**226300FX** straight, serrated / WL 13 cm  
gerade, gezahnt / NL 13 cm

**226300FXF** straight, serrated / WL 13 cm, with flush connector  
gerade, gezahnt / NL 13 cm, mit Spülanschluss

**226301FX** curved left, serrated / WL 13 cm  
links gebogen, gezahnt / NL 13 cm

**226301FXF** curved left, serrated / WL 13 cm, with flush connector  
links gebogen, gezahnt / NL 13 cm, mit Spülanschluss

**226302FX** curved right, serrated / WL 13 cm  
rechts gebogen, gezahnt / NL 13 cm

**226302FXF** curved right, serrated / WL 13 cm, with flush connector  
rechts gebogen, gezahnt / NL 13 cm, mit Spülanschluss

**226303FX** curved up, serrated / WL 13 cm  
aufwärts gebogen, gezahnt / NL 13 cm

**226304FX** curved down, serrated / WL 13 cm  
abwärts gebogen, gezahnt / NL 13 cm

**Sinus Surgery**  
**Nasennebenhöhlen**



**226400FX** **Nasal Scissors**, straight, smooth, WL 11.5 cm  
**Nasenschere**, gerade, glatt, NL 11,5 cm

<b>226400FX</b>	straight, smooth / WL 11.5 cm	gerade, glatt / NL 11,5 cm
<b>226401FX</b>	curved left, smooth / WL 11.5 cm	links gebogen, glatt / NL 11,5 cm
<b>226402FX</b>	curved right, smooth / WL 11.5 cm	rechts gebogen, glatt / NL 11,5 cm



**226100FX** **Nasal Scissors by Heymann**, standard, smooth blades, WL 9.5 cm  
**Nasenschere nach Heymann**, Standard, glatte Schneiden, NL 9,5 cm

<b>226100FX</b>	standard, smooth blades / WL 9.5 cm	Standard, glatte Schneiden / NL 9,5 cm
<b>226109FX</b>	small, smooth blades / WL 9 cm	klein, glatte Schneiden / NL 9 cm
<b>226111FX</b>	large, smooth blades / WL 11 cm	groß, glatte Schneiden / NL 11 cm
<b>226200FX</b>	standard, serrated blades / WL 9.5 cm	Standard, gezahnte Schneiden / NL 9,5 cm
<b>226201FX</b>	small, curved left, smooth blades / WL 9.5 cm	klein, links gebogen, glatte Schneiden / NL 9,5 cm
<b>226202FX</b>	small, curved right, smooth blades / WL 9.5 cm	klein, rechts gebogen, glatte Schneiden / NL 9,5 cm



- 412502FX** **Bone Punch**, through-cutting, with hooked jaw, WL 18 cm, width 2 mm  
**Knochenstanze**, durchschneidend, mit Hakenmaul, NL 18 cm, Schnittbreite 2 mm
- 412503FX** **Bone Punch**, through-cutting, with hooked jaw, WL 15 cm, width 3 mm  
**Knochenstanze**, durchschneidend, mit Hakenmaul, NL 15 cm, Schnittbreite 3 mm

**Sinus Surgery**  
**Nasennebenhöhlen**



**413021FX**

**413021FX** **Sphenoid Punch by FS-Kerrison, 40° upbiting, detachable, WL 18 cm, width 1 mm**  
**Knochenstanze nach FS-Kerrison, 40° nach oben schneidend, zerlegbar, NL 18 cm, Schnittbreite 1 mm**

**413001FX** 90° upbiting, detachable / WL 18 cm, width 1 mm  
 90° nach oben schneidend, zerlegbar / NL 18 cm, Schnittbreite 1 mm

**413002FX** 90° upbiting, detachable / WL 18 cm, width 2 mm  
 90° nach oben schneidend, zerlegbar / NL 18 cm, Schnittbreite 2 mm

**413003FX** 90° upbiting, detachable / WL 18 cm, width 3 mm  
 90° nach oben schneidend, zerlegbar / NL 18 cm, Schnittbreite 3 mm

**413004FX** 90° upbiting, detachable / WL 18 cm, width 4 mm  
 90° nach oben schneidend, zerlegbar / NL 18 cm, Schnittbreite 4 mm

**413021FX** 40° upbiting, detachable / WL 18 cm, width 1 mm  
 40° nach oben schneidend, zerlegbar / NL 18 cm, Schnittbreite 1 mm

**413022FX** 40° upbiting, detachable / WL 18 cm, width 2 mm  
 40° nach oben schneidend, zerlegbar / NL 18 cm, Schnittbreite 2 mm

**413023FX** 40° upbiting, detachable / WL 18 cm, width 3 mm  
 40° nach oben schneidend, zerlegbar / NL 18 cm, Schnittbreite 3 mm

**413024FX** 40° upbiting, detachable / WL 18 cm, width 4 mm  
 40° nach oben schneidend, zerlegbar / NL 18 cm, Schnittbreite 4 mm

**413402FX** 90° downbiting, detachable / WL 18 cm, width 2 mm  
 90° nach unten schneidend, zerlegbar / NL 18 cm, Schnittbreite 2 mm

**413403FX** 90° downbiting, detachable / WL 18 cm, width 3 mm  
 90° nach unten schneidend, zerlegbar / NL 18 cm, Schnittbreite 3 mm

**413404FX** 90° downbiting, detachable / WL 18 cm, width 4 mm  
 90° nach unten schneidend, zerlegbar / NL 18 cm, Schnittbreite 4 mm



**412101FX** **Sphenoid Punch by Hajek-Kofler**, 90° upbiting, WL 14 cm, width 4 mm  
**Knochenstanze nach Hajek-Kofler**, 90° nach oben schneidend, NL 14 cm, Schnittbreite 4 mm



**412101FX**



**412102FX**



**412301FX**



**412302FX**



**412401FX**



**412402FX**

**412101FX** 90° upbiting / WL 14 cm, width 4 mm  
 90° nach oben schneidend / NL 14 cm, Schnittbreite 4 mm

**412102FX** 90° downbiting cutting / WL 14 cm, width 4 mm  
 90° nach unten schneidend / NL 14 cm, Schnittbreite 4 mm

**412301FX** 40° upbiting backward cutting / WL 14 cm, width 4 mm  
 40° nach oben rückwärts schneidend / NL 14 cm, Schnittbreite 4 mm

**412302FX** 40° downbiting backward cutting / WL 14 cm, width 4 mm  
 40° nach unten rückwärts schneidend / NL 14 cm, Schnittbreite 4 mm

**412401FX** 40° upbiting forward cutting / WL 14 cm, width 4 mm  
 40° nach oben vorwärts schneidend / NL 14 cm, Schnittbreite 4 mm

**412402FX** 40° upbiting forward cutting / WL 14 cm, width 2 mm  
 40° nach oben vorwärts schneidend / NL 14 cm, Schnittbreite 2 mm

**Sinus Surgery**  
**Nasennebenhöhlen**



**412600FX**

**412600FX** **Antrum Punch by Beyer**, 90° upbiting, WL 9 cm, width 2 mm  
**Kieferhöhlenstanze nach Beyer**, 90° nach oben schneidend, NL 9 cm, Schnittbreite 2 mm

**412601FX** **Antrum Punch by Beyer**, 90° upbiting, WL 9 cm, width 1 mm  
**Kieferhöhlenstanze nach Beyer**, 90° nach oben schneidend, NL 9 cm, Schnittbreite 1 mm



**413100FX**

**413100FX** **Sphenoid Punch by Hajek-Kofler**, 90° upbiting, 360° rotatable, WL 17 cm, width 3 mm  
**Knochenstanze nach Hajek-Kofler**, 90° nach oben schneidend, 360° drehbar, NL 17 cm, Schnittbreite 3 mm



**413200FX** **Sphenoid Punch by McKenty**, through-cutting, rotatable, WL 14.5 cm, width 2 mm  
**Keilbeinstanze nach McKenty**, durchschneidend, drehbar, NL 14,5 cm, Schnittbreite 2 mm



**412702FX**



**412702FX** **Frontal Sinus Punch**, 70° upturned sheath, 40° upbiting, WL 14 cm, width 2 mm  
**Stirnhöhlenstanze**, 70° aufgebog.Schaft, 40° oben schneidend, NL 14 cm, Schnittbreite 2 mm

**412703FX** **Frontal Sinus Punch**, 70° upturned sheath, 40° upbiting, WL 14 cm, width 3 mm  
**Stirnhöhlenstanze**, 70° aufgebog.Schaft, 40° oben schneidend, NL 14 cm, Schnittbreite 3 mm

**Sinus Surgery**  
**Nasennebenhöhlen**



**234603FX**

- 234603FX**    **Circular Cutting Punch**, 70° upcurved, with flush connector, WL 13 cm, Ø 3.5 mm  
**Rundkopfstanze**, 70° aufgebogen, mit Spülanschluss, NL 13 cm, Ø 3,5 mm
- 234606FX**    **Circular Cutting Punch**, 70° upcurved, with flush connector, WL 13 cm, Ø 4.5 mm  
**Rundkopfstanze**, 70° aufgebogen, mit Spülanschluss, NL 13 cm, Ø 4,5 mm



**234835FX**

**234835FX** **Circular Cutting Punch**, straight, with flush connector, WL 16 cm, Ø 3.5 mm  
**Rundkopfstanze**, gerade, mit Spülanschluss, NL 16 cm, Ø 3,5 mm

**234845FX** **Circular Cutting Punch**, straight, with flush connector, WL 16 cm, Ø 4.5 mm  
**Rundkopfstanze**, gerade, mit Spülanschluss, NL 16 cm, Ø 4,5 mm



**234865FX**

**234865FX** **Circular Cutting Punch**, 65° upturned, with flush connector, WL 16 cm, Ø 3.5 mm  
**Rundkopfstanze**, 65° aufgebogen, mit Spülanschluss, NL 16 cm, Ø 3,5 mm

**234866FX** **Circular Cutting Punch**, 65° upturned, with flush connector, WL 16 cm, Ø 4.5 mm  
**Rundkopfstanze**, 65° aufgebogen, mit Spülanschluss, NL 16 cm, Ø 4,5 mm

**Sinus Surgery**  
**Nasennebenhöhlen**



235036FXF



**235036FXF** **Circular Cutting Punch (Gear Type)**, straight, with flush connector, WL 18 cm, Ø 3.5 mm  
**Rundkopfstanze (Zahnradmechanik)**, gerade, mit Spülanschluss, NL 18 cm, Ø 3,5 mm



235046FXF



**235046FXF** **Circular Cutting Punch (Gear Type)**, straight, with flush connector, WL 18 cm, Ø 4.5 mm  
**Rundkopfstanze (Zahnradmechanik)**, gerade, mit Spülanschluss, NL 18 cm, Ø 4,5 mm



235066FXF



**235066FXF** **Circular Cutting Punch (Gear Type)**, 65° upturned, with flush connector, WL 18 cm, Ø 3.5 mm  
**Rundkopfstanze (Zahnradmechanik)**, 65° aufgebogen, mit Spülanschluss, NL 18 cm, Ø 3,5 mm



235076FXF



**235076FXF** **Circular Cutting Punch (Gear Type)**, 65° upturned, with flush connector, WL 18 cm, Ø 4.5 mm  
**Rundkopfstanze (Zahnradmechanik)**, 65° aufgebogen, mit Spülanschluss, NL 18 cm, Ø 4,5 mm

**Sinus Surgery**  
**Nasennebenhöhlen**



**235035FXF**

**235035FX** **Circular Cutting Punch**, straight, WL 18 cm, Ø 3.5 mm  
**Rundkopfstanze**, gerade, NL 18 cm, Ø 3,5 mm

**235035FX** straight / WL 18 cm, Ø 3.5 mm  
gerade / NL 18 cm, Ø 3,5 mm

**235035FXF** straight, with flush connector / WL 18 cm, Ø 3.5 mm  
gerade, mit Spülanschluss / NL 18 cm, Ø 3,5 mm

**235045FX** straight / WL 18 cm, Ø 4.5 mm  
gerade / NL 18 cm, Ø 4,5 mm

**235045FXF** straight, with flush connector / WL 18 cm, Ø 4.5 mm  
gerade, mit Spülanschluss / NL 18 cm, Ø 4,5 mm



**235065FX**

**235065FX** **Circular Cutting Punch**, 60° upturned, WL 18 cm, Ø 3.5 mm  
**Rundkopfstanze**, 60° aufgebogen, NL 18 cm, Ø 3,5 mm

**235065FX** 60° upturned / WL 18 cm, Ø 3.5 mm  
60° aufgebogen / NL 18 cm, Ø 3,5 mm

**235065FXF** 60° upturned, with flush connector / WL 18 cm, Ø 3.5 mm  
60° aufgebogen, mit Spülanschluss / NL 18 cm, Ø 3,5 mm

**235075FX** 60° upturned / WL 18 cm, Ø 4.5 mm  
60° aufgebogen / NL 18 cm, Ø 4,5 mm

**235075FXF** 60° upturned, with flush connector / WL 18 cm, Ø 4.5 mm  
60° aufgebogen, mit Spülanschluss / NL 18 cm, Ø 4,5 mm



**236311FX** **Frontal Sinus Punch**, 45°, vertical, with flush connector, WL 13 cm, Ø 2 mm through-cutting  
**Stirnhöhlen-Stanze**, 45°, vertikal, mit Spülanschluss, NL 13 cm, Ø 2 mm durchschneidend

**236311FX** 45°, vertical, with flush connector / WL 13 cm, Ø 2 mm through-cutting  
 45°, vertikal, mit Spülanschluss / NL 13 cm, Ø 2 mm durchschneidend

**236312FX** 45°, horizontal, with flush connector / WL 13 cm, Ø 2 mm through-cutting  
 45°, horizontal, mit Spülanschluss / NL 13 cm, Ø 2 mm durchschneidend

**236313FX** 90°, vertical, with flush connector / WL 13 cm, Ø 2 mm through-cutting  
 90°, vertikal, mit Spülanschluss / NL 13 cm, Ø 2 mm durchschneidend

**236314FX** 90°, horizontal, with flush connector / WL 13 cm, Ø 2 mm through-cutting  
 90°, horizontal, mit Spülanschluss / NL 13 cm, Ø 2 mm durchschneidend

**236333FX** 45°, vertical, with flush connector / WL 13 cm, Ø 3 mm through-cutting  
 45°, vertikal, mit Spülanschluss / NL 13 cm, Ø 3 mm durchschneidend

**236334FX** 45°, horizontal, with flush connector / WL 13 cm, Ø 3 mm through-cutting  
 45°, horizontal, mit Spülanschluss / NL 13 cm, Ø 3 mm durchschneidend

**236343FX** 90°, vertical, with flush connector / WL 13 cm, Ø 3 mm through-cutting  
 90°, vertikal, mit Spülanschluss / NL 13 cm, Ø 3 mm durchschneidend

**236344FX** 90°, horizontal, with flush connector / WL 13 cm, Ø 3 mm through-cutting  
 90°, horizontal, mit Spülanschluss / NL 13 cm, Ø 3 mm durchschneidend

**Sinus Surgery**  
**Nasennebenhöhlen**



**236301FX**

**236301FX** **Frontal Sinus Punch**, 55°, vertical, WL 14.5 cm, Ø 2 mm through-cutting  
**Stirnhöhlen-Stanze**, 55°, vertikal, NL 14,5 cm, Ø 2 mm durchschneidend

**236301FX** 55°, vertical / WL 14.5 cm, Ø 2 mm through-cutting  
 55°, vertikal / NL 14,5 cm, Ø 2 mm durchschneidend

**236301FXF** 55°, vertical, with flush connector / WL 14.5 cm, Ø 2 mm through-cutting  
 55°, vertikal, mit Spülanschluss / NL 14,5 cm, Ø 2 mm durchschneidend

**236302FX** 55°, horizontal / WL 14.5 cm, Ø 2 mm through-cutting  
 55°, horizontal / NL 14,5 cm, Ø 2 mm durchschneidend

**236302FXF** 55°, horizontal, with flush connector / WL 14.5 cm, Ø 2 mm through-cutting  
 55°, horizontal, mit Spülanschluss / NL 14,5 cm, Ø 2 mm durchschneidend



**236303FX**

**236303FX** **Frontal Sinus Punch**, 90°, vertical, WL 14.5 cm, Ø 2 mm through-cutting  
**Stirnhöhlen-Stanze**, 90°, vertikal, NL 14,5 cm, Ø 2 mm durchschneidend

**236303FX** 90°, vertical / WL 14.5 cm, Ø 2 mm through-cutting  
 90°, vertikal / NL 14,5 cm, Ø 2 mm durchschneidend

**236303FXF** 90°, vertical, with flush connector / WL 14.5 cm, Ø 2 mm through-cutting  
 90°, vertikal, mit Spülanschluss / NL 14,5 cm, Ø 2 mm durchschneidend

**236304FX** 90°, horizontal / WL 14.5 cm, Ø 2 mm through-cutting  
 90°, horizontal / NL 14,5 cm, Ø 2 mm durchschneidend

**236304FXF** 90°, horizontal, with flush connector / WL 14.5 cm, Ø 2 mm through-cutting  
 90°, horizontal, mit Spülanschluss / NL 14,5 cm, Ø 2 mm durchschneidend



**235501FX** **Double Spoon Forceps**, 55°, vertical, WL 14.5 cm, spoon Ø 3 mm  
**Doppellöffel-Zange**, 55°, vertikal, NL 14,5 cm, Löffel Ø 3 mm

**235503FX** 55°, vertical / WL 14.5 cm, spoon Ø 2 mm  
 55°, vertikal / NL 14,5 cm, Löffel Ø 2 mm

**235504FX** 55°, horizontal / WL 14.5 cm, spoon Ø 2 mm  
 55°, horizontal / NL 14,5 cm, Löffel Ø 2 mm

**235501FX** 55°, vertical / WL 14.5 cm, spoon Ø 3 mm  
 55°, vertikal / NL 14,5 cm, Löffel Ø 3 mm

**235501FXF** 55°, vertical, with flush connector / WL 14.5 cm, spoon Ø 3 mm  
 55°, vertikal, mit Spülanschluss / NL 14,5 cm, Löffel Ø 3 mm

**235502FX** 55°, horizontal / WL 14.5 cm, spoon Ø 3 mm  
 55°, horizontal / NL 14,5 cm, Löffel Ø 3 mm

**235502FXF** 55°, horizontal, with flush connector / WL 14.5 cm, spoon Ø 3 mm  
 55°, horizontal, mit Spülanschluss / NL 14,5 cm, Löffel Ø 3 mm

**235513FX** 55°, vertical / WL 14.5 cm, spoon Ø 4 mm  
 55°, vertikal / NL 14,5 cm, Löffel Ø 4 mm

**235513FXF** 55°, vertical, with flush connector / WL 14.5 cm, spoon Ø 4 mm  
 55°, vertikal, mit Spülanschluss / NL 14,5 cm, Löffel Ø 4 mm

**235514FX** 55°, horizontal / WL 14.5 cm, spoon Ø 4 mm  
 55°, horizontal / NL 14,5 cm, Löffel Ø 4 mm

**235514FXF** 55°, horizontal, with flush connector / WL 14.5 cm, spoon Ø 4 mm  
 55°, horizontal, mit Spülanschluss / NL 14,5 cm, Löffel Ø 4 mm

**Sinus Surgery**  
**Nasennebenhöhlen**



**235505FX** **Double Spoon Forceps**, 90°, vertical, WL 14.5 cm, spoon Ø 2 mm  
**Doppellöffel-Zange**, 90°, vertikal, NL 14,5 cm, Löffel Ø 2 mm

**235505FX** 90°, vertical / WL 14.5 cm, spoon Ø 2 mm  
 90°, vertikal / NL 14,5 cm, Löffel Ø 2 mm

**235505FXF** 90°, vertical, with flush connector / WL 14.5 cm, spoon Ø 2 mm  
 90°, vertikal, mit Spülanschluss / NL 14,5 cm, Löffel Ø 2 mm

**235506FX** 90°, horizontal / WL 14.5 cm, spoon Ø 2 mm  
 90°, horizontal / NL 14,5 cm, Löffel Ø 2 mm

**235506FXF** 90°, horizontal, with flush connector / WL 14.5 cm, spoon Ø 2 mm  
 90°, horizontal, mit Spülanschluss / NL 14,5 cm, Löffel Ø 2 mm

**235507FX** 90°, vertical / WL 14.5 cm, spoon Ø 3 mm  
 90°, vertikal / NL 14,5 cm, Löffel Ø 3 mm

**235508FX** 90°, horizontal / WL 14.5 cm, spoon Ø 3 mm  
 90°, horizontal / NL 14,5 cm, Löffel Ø 3 mm

**235508FXF** 90°, horizontal, with flush connector / WL 14.5 cm, spoon Ø 3 mm  
 90°, horizontal, mit Spülanschluss / NL 14,5 cm, Löffel Ø 3 mm

**235509FX** 90°, vertical / WL 14.5 cm, spoon Ø 4 mm  
 90°, vertikal / NL 14,5 cm, Löffel Ø 4 mm

**235509FXF** 90°, vertical, with flush connector / WL 14.5 cm, spoon Ø 4 mm  
 90°, vertikal, mit Spülanschluss / NL 14,5 cm, Löffel Ø 4 mm

**235510FX** 90°, horizontal / WL 14.5 cm, spoon Ø 4 mm  
 90°, horizontal / NL 14,5 cm, Löffel Ø 4 mm

**235510FXF** 90°, horizontal, with flush connector / WL 14.5 cm, spoon Ø 4 mm  
 90°, horizontal, mit Spülanschluss / NL 14,5 cm, Löffel Ø 4 mm



**235224FX**



**235224FX** **Double Spoon Forceps**, 110°, vertical, oval, WL 14 cm, spoon Ø 4 mm  
**Doppellöffel-Zange**, 110°, vertikal, NL 14 cm, Löffel Ø 4 mm

**235210FX** 110°, horizontal, oval / WL 14 cm, spoon Ø 2.6 mm  
 110°, horizontal / NL 14 cm, Löffel Ø 2,6 mm

**235211FX** 110°, vertical, oval / WL 14 cm, spoon Ø 2.6 mm  
 110°, vertikal, oval / NL 14 cm, Löffel Ø 2,6 mm

**235214FX** 110°, horizontal, oval / WL 14 cm, spoon Ø 4 mm  
 110°, horizontal, oval / NL 14 cm, Löffel Ø 4 mm

**235224FX** 110°, vertical, oval / WL 14 cm, spoon Ø 4 mm  
 110°, vertikal / NL 14 cm, Löffel Ø 4 mm

**Sinus Surgery**  
**Nasennebenhöhlen**



**235270FX**



**235270FX** **Double Spoon Forceps**, 70°, horizontal, oval, WL 14 cm, spoon Ø 2.6 mm  
**Doppellöffel-Zange**, 70°, horizontal, NL 14 cm, Löffel Ø 2,6 mm

**235270FX** 70°, horizontal, oval / WL 14 cm, spoon Ø 2.6 mm  
 70°, horizontal / NL 14 cm, Löffel Ø 2,6 mm

**235270FXF** 70°, horiz., oval, with flush connector / WL 14 cm, spoon Ø 2.6 mm  
 70°, horizontal, mit Spülanschluss / NL 14 cm, Löffel Ø 2,6 mm

**235271FX** 70°, vertical, oval / WL 14 cm, spoon Ø 2.6 mm  
 70°, vertikal / NL 14 cm, Löffel Ø 2,6 mm

**235271FXF** 70°, vert., oval, with flush connector / WL 14 cm, spoon Ø 2.6 mm  
 70°, vertikal, mit Spülanschluss / NL 14 cm, Löffel Ø 2,6 mm



**415100FX** **Biopsy and Grasping Forceps**, double-action, oval, w. flush connector, WL 15 cm, spoon 2.5 x 3 mm  
**Probeexzisions- und Fasszange**, doppelbeweglich, oval, mit Spülanschluss, NL 15 cm, Löffel 2,5 x 3 mm

**Sinus Surgery**  
**Nasennebenhöhlen**



**415105FX**

**415105FX** **Biopsy and Grasping Forceps**, double-action, round, WL 18 cm, spoon Ø 4 mm  
**Probeexzisions- und Fasszange**, doppelbeweglich, rund, NL 18 cm, Löffel Ø 4 mm



**415170FX** **Maxillary Biopsy Forceps**, sheath 70° down, vertical opening, WL 12 cm, spoon Ø 3 mm  
**Kieferhöhlen Probeexzisionszange**, Schaft 70° abgebogen, vertikal öffnend, NL 12 cm, Löffel Ø 3 mm



**415210FX** **Maxillary Biopsy Forceps**, sheath 110° down, horizontal opening, WL 13 cm, spoon 3 x 6 mm, with LL  
**Kieferhöhlen Probeexzisionszange**, Schaft 110° abgebogen, seitlich öffnend, NL 13 cm, Löffel 3 x 6 mm, mit LL



236500FX



236501FX



236502FX

**236500FX** **S-Bite Nasal Forceps**, straight, serrated, through-cutting, WL 13 cm, bite 2 mm  
**S-Bite Nasenzange**, gerade, gezahnt, durchschneidend, NL 13 cm, Ausstanzung 2 mm

**236500FX** straight, serrated, through-cutting / WL 13 cm, bite 2 mm  
gerade, gezahnt, durchschneidend / NL 13 cm, Ausstanzung 2 mm

**236501FX** straight, serrated, through-cutting / WL 13 cm, bite 2.5 mm  
gerade, gezahnt, durchschneidend / NL 13 cm, Ausstanzung 2,5 mm

**236502FX** straight, serrated, through-cutting / WL 13 cm, bite 3 mm  
gerade, gezahnt, durchschneidend / NL 13 cm, Ausstanzung 3 mm



**236600FX**



**236601FX**



**236602FX**

**236600FX** **S-Bite Nasal Forceps**, 45° upcurved, serrated, through-cutting, WL 13 cm, bite 2 mm  
**S-Bite Nasenzange**, 45° aufgebogen, gezahnt, durchschneidend, NL 13 cm, Ausstanzung 2 mm

**236600FX** 45° upcurved, serrated, through-cutting / WL 13 cm, bite 2 mm  
 45° aufgebogen, gezahnt, durchschneidend / NL 13 cm, Ausstanzung 2 mm

**236601FX** 45° upcurved, serrated, through-cutting / WL 13 cm, bite 2.5 mm  
 45° aufgebogen, gezahnt, durchschneidend / NL 13 cm, Ausstanzung 2,5 mm

**236602FX** 45° upcurved, serrated, through-cutting / WL 13 cm, bite 3 mm  
 45° aufgebogen, gezahnt, durchschneidend / NL 13 cm, Ausstanzung 3 mm

**Sinus Surgery**  
**Nasennebenhöhlen**



**235300FX**



**235300FX**

**Suction Forceps by Gruenwald**, straight, through-cutting, WL 10 cm, bite 2 mm  
**Saugzange nach Grünwald**, gerade, durchschneidend, NL 10 cm, Ausschnitt 2 mm



**236702FX**



**236702FX** **S-Bite Nasal Forceps**, 70°, vertical, serrated, through-cutting, WL 13 cm, bite 2 mm, long curved  
**S-Bite Nasenzange**, 70°, vertikal, gezahnt, durchschneidend, NL 13 cm, Ausschnitt 2 mm, lange Biegung

**236702FX** 70°, vertical, serrated, through-cutting / WL 13 cm, bite 2 mm, long curved  
 70°, vertikal, gezahnt, durchschneidend / NL 13 cm, Ausschnitt 2 mm, lange Biegung

**236703FX** 70°, right, serrated, through-cutting / WL 13 cm, bite 2 mm, long curved  
 70°, rechts, gezahnt, durchschneidend / NL 13 cm, Ausschnitt 2 mm, lange Biegung

**236704FX** 70° left, serrated, through-cutting / WL 13 cm, bite 2 mm, long curved  
 70° links, gezahnt, durchschneidend / NL 13 cm, Ausschnitt 2 mm, lange Biegung

**236712FX** 70°, vertical, serrated, through-cutting / WL 13 cm, bite 2 mm, short curved  
 70°, vertikal, gezahnt, durchschneidend / NL 13 cm, Ausschnitt 2 mm, kurze Biegung

**Sinus Surgery**  
**Nasennebenhöhlen**



**226901FX**



**226901FX** **Nasal Forceps**, straight, through cutting, small, WL 14 cm  
**Nasenzange**, gerade, durchschneidend, klein, NL 14 cm



**226902FX**



**226902FX** **Nasal Forceps**, 45° upturned, through-cutting, small, WL 14 cm  
**Nasenzange**, 45° aufgebogen, durchschneidend, klein, NL 14 cm



**226903FX**



**226903FX** **Nasal Forceps**, shaft curved up, through-cutting, small, WL 14 cm  
**Nasenzange**, Schaft aufgebog., durchschneidend, klein, NL 14 cm

**Sinus Surgery**  
**Nasennebenhöhlen**



**226915FX**



**226915FX**

**Nasal Forceps**, 45° upturned, through-cutting, small, WL 14 cm  
**Nasenzange**, 45° aufgebogen, durchschneidend, klein, NL 14 cm



**226904FX**



**226904FX**

**Nasal Spoon Forceps**, straight, oval cup, WL 14 cm  
**Nasenlöffelzange**, gerade, ovaler Löffel, NL 14 cm

**Sinus Surgery**  
**Nasennebenhöhlen**



**226905FX**



**226905FX** **Nasal Spoon Forceps**, 45° upturned, oval cup, WL 14 cm  
**Nasenlöffelzange**, 45° aufgebogen, ovaler Löffel, NL 14 cm



**226906FX**



**226906FX** **Nasal Spoon Forceps**, shaft curved up, oval cup, WL 14 cm  
**Nasenlöffelzange**, Schaft aufgebogen, ovaler Löffel, NL 14 cm

**Sinus Surgery**  
**Nasennebenhöhlen**



**226908FX**



**226908FX**

**Nasal Forceps**, shaft curved up, through-cutting, large, WL 14 cm  
**Nasenzange**, Schaft aufgebog., durchschneidend, groß, NL 14 cm



**226909FX**



**226909FX**

**Nasal Spoon Forceps**, shaft curved up, oval cup, medium, WL 14 cm  
**Nasenlöffelzange**, Schaft aufgebog., ovaler Löffel, mittel, NL 14 cm

**Sinus Surgery**  
**Nasennebenhöhlen**



**226910FX**



**226910FX** **Nasal Forceps**, straight, through-cutting, small, WL 11.5 cm  
**Nasenzange**, gerade, durchschneidend, klein, NL 11,5 cm



**226911FX**



**226911FX** **Nasal Forceps**, straight, through-cutting, large, WL 11.5 cm  
**Nasenzange**, gerade, durchschneidend, groß, NL 11,5 cm



**226912FX**



**226912FX**

**Nasal Forceps**, 45° upturned, through-cutting, small, WL 11.5 cm  
**Nasenzange**, 45° aufgebogen, durchschneidend, klein, NL 11,5 cm



**226913FX**



**226913FX**

**Nasal Forceps**, 45° upturned, through-cutting, medium, WL 11.5 cm  
**Nasenzange**, 45° aufgebogen, durchschneidend, mittel, NL 11,5 cm

**Sinus Surgery**  
**Nasennebenhöhlen**



**226914FX**



**226914FX**





**Nasal Forceps**, 45° upturned, through-cutting, large, WL 11.5 cm

**Nasenzange**, 45° aufgebogen, durchschneidend, groß, NL 11,5 cm



**230100FX** **Nasal Forceps by Blakesley**, straight, WL 11.5 cm, size 0  
**Nasenzange nach Blakesley**, gerade, NL 11,5 cm, Fig. 0



Pattern Schneide	Size Fig.	0°	45°	90°
	0 = 3,0 mm	230100FX	230200FX	230300FX
	1 = 3,5 mm	230101FX	230201FX	230301FX
	2 = 4,0 mm	230102FX	230202FX	230302FX
	3 = 5,0 mm	230103FX	230203FX	230303FX
	4 = 5,5 mm	230104FX	230204FX	-

<b>230100FX</b>	straight / WL 11.5 cm, size 0	gerade / NL 11,5 cm, Fig. 0
<b>230101FX</b>	straight / WL 11.5 cm, size 1	gerade / NL 11,5 cm, Fig. 1
<b>230102FX</b>	straight / WL 11.5 cm, size 2	gerade / NL 11,5 cm, Fig. 2
<b>230103FX</b>	straight / WL 11.5 cm, size 3	gerade / NL 11,5 cm, Fig. 3
<b>230104FX</b>	straight / WL 11.5 cm, size 4	gerade / NL 11,5 cm, Fig. 4
<b>230200FX</b>	45° upturned / WL 11.5 cm, size 0	45° aufgebogen / NL 11,5 cm, Fig. 0
<b>230201FX</b>	45° upturned / WL 11.5 cm, size 1	45° aufgebogen / NL 11,5 cm, Fig. 1
<b>230202FX</b>	45° upturned / WL 11.5 cm, size 2	45° aufgebogen / NL 11,5 cm, Fig. 2
<b>230203FX</b>	45° upturned / WL 11.5 cm, size 3	45° aufgebogen / NL 11,5 cm, Fig. 3
<b>230204FX</b>	45° upturned / WL 11.5 cm, size 4	45° aufgebogen / NL 11,5 cm, Fig. 4
<b>230300FX</b>	90° upturned / WL 11.5 cm, size 0	90° aufgebogen / NL 11,5 cm, Fig. 0
<b>230301FX</b>	90° upturned / WL 11.5 cm, size 1	90° aufgebogen / NL 11,5 cm, Fig. 1
<b>230302FX</b>	90° upturned / WL 11.5 cm, size 2	90° aufgebogen / NL 11,5 cm, Fig. 2
<b>230303FX</b>	90° upturned / WL 11.5 cm, size 3	90° aufgebogen / NL 11,5 cm, Fig. 3



**231601FX** **Nasal Forceps by Blakesley**, straight, WL 15 cm, size 1  
**Nasenzange nach Blakesley**, gerade, NL 15 cm, Fig. 1



Pattern Schneide	Size Fig.	0°	45°	90°
	1 = 3,5 mm	231601FX	231701FX	231801FX
	2 = 4,0 mm	231602FX	231702FX	231802FX
	3 = 5,0 mm	231603FX	-	-

<b>231601FX</b>	straight / WL 15 cm, size 1	gerade / NL 15 cm, Fig. 1
<b>231602FX</b>	straight / WL 15 cm, size 2	gerade / NL 15 cm, Fig. 2
<b>231603FX</b>	straight / WL 15 cm, size 3	gerade / NL 15 cm, Fig. 3
<b>231701FX</b>	45° upturned / WL 15 cm, size 1	45° aufgebogen / NL 15 cm, Fig. 1
<b>231702FX</b>	45° upturned / WL 15 cm, size 2	45° aufgebogen / NL 15 cm, Fig. 2
<b>231801FX</b>	90° upturned / WL 15 cm, size 1	90° aufgebogen / NL 15 cm, Fig. 1
<b>231802FX</b>	90° upturned / WL 15 cm, size 2	90° aufgebogen / NL 15 cm, Fig. 2



**230140FX** **Nasal Forceps by Blakesley**, straight, semi-detachable, WL 12 cm, Size 0  
**Nasenzange nach Blakesley**, gerade, teilzerlegbar, NL 12 cm, Fig. 0

**230140FX** straight, semi-detachable / WL 12 cm, Size 0  
gerade, teilzerlegbar / NL 12 cm, Fig. 0

**230141FX** straight, semi-detachable / WL 12 cm, Size 1  
gerade, teilzerlegbar / NL 12 cm, Fig. 1

**230142FX** straight, semi-detachable / WL 12 cm, size 2  
gerade, teilzerlegbar / NL 12 cm, Fig. 2

**230240FX** 45° upturned, semi-detachable / WL 12 cm, Size 0  
45° aufgebogen, teilzerlegbar / NL 12 cm, Fig. 0

**230241FX** 45° upturned, semi-detachable / WL 12 cm, Size 1  
45° aufgebogen, teilzerlegbar / NL 12 cm, Fig. 1

**230242FX** 45° upturned, semi-detachable / WL 12 cm, Size 2  
45° aufgebogen, teilzerlegbar / NL 12 cm, Fig. 2

**230340FX** 90° upturned, semi-detachable / WL 12 cm, Size 0  
90° aufgebogen, teilzerlegbar / NL 12 cm, Fig. 0

**230341FX** 90° upturned, semi-detachable / WL 12 cm, Size 1  
90° aufgebogen, teilzerlegbar / NL 12 cm, Fig. 1

**230342FX** 90° upturned, semi-detachable / WL 12 cm, Size 2  
90° aufgebogen, teilzerlegbar / NL 12 cm, Fig. 2

**Sinus Surgery**  
**Nasennebenhöhlen**



**230600FX**



**230700FX**



**230600FX** **Nasal Forceps by Blakesley**, curved left, WL 10 cm, size 1  
**Nasenzange nach Blakesley**, nach links gebogen, NL 10 cm, Fig. 1

**230700FX** **Nasal Forceps by Blakesley**, curved right, WL 10 cm, size 1  
**Nasenzange nach Blakesley**, nach rechts gebogen, NL 10 cm, Fig. 1



**236901FX**



**236901FX** **Suction Forceps by Blakesley**, straight, WL 10 cm, size 1  
**Saugzange nach Blakesley**, gerade, NL 10 cm, Fig. 1



**237001FX**



**237001FX** **Suction Forceps by Blakesley**, 30° upturned, WL 10 cm, size 1  
**Saugzange nach Blakesley**, 30° aufgebogen, NL 10 cm, Fig. 1



**235901FX**



**235901FX** **Nasal Forceps by Blakesley**, straight, through-cutting, WL 11 cm, size 1  
**Nasenzange nach Blakesley**, gerade, durchschneidend, NL 11 cm, Fig. 1

**Sinus Surgery**  
**Nasennebenhöhlen**



**236000FX**



**236000FX** **Nasal Forceps by Blakesley**, 45° upturned, through-cutting, WL 11 cm, size 0  
**Nasenzange nach Blakesley**, 45° aufgebogen, durchschneidend, NL 11 cm, Fig. 0

**236000FX** 45° upturned, through-cutting / WL 11 cm, size 0  
 45° aufgebogen, durchschneidend / NL 11 cm, Fig. 0

**236001FX** 45° upturned, through-cutting / WL 11 cm, size 1  
 45° aufgebogen, durchschneidend / NL 11 cm, Fig. 1

**236002FX** 45° upturned, through-cutting / WL 11 cm, size 2  
 45° aufgebogen, durchschneidend / NL 11 cm, Fig. 2



**227600FX**



**227600FX** **Nasal Cutting Forceps by Struycken**, WL 12 cm  
**Conchotom nach Struycken**, NL 12 cm



**228601FX** **Nasal Cutting Forceps by Gruenwald-Henke**, through-cutting, WL 11 cm, size 1  
**Conchotom nach Grünwald-Henke**, durchschneidend, NL 11 cm, Fig. 1

<b>228601FX</b>	through-cutting / WL 11 cm, size 1	durchschneidend / NL 11 cm, Fig. 1
<b>228602FX</b>	through-cutting / WL 11 cm, size 2	durchschneidend / NL 11 cm, Fig. 2
<b>228603FX</b>	through-cutting / WL 11 cm, size 3	durchschneidend / NL 11 cm, Fig. 3



**234300FX**

**234300FX** **Nasal Forceps by Wigand**, straight, through-cutting, WL 14 cm, bite 3 x 4 mm  
**Nasenzange nach Wigand**, gerade, durchschneidend, NL 14 cm, Schnittgröße 3 x 4 mm

**234345FX** **Nasal Forceps by Wigand**, 45° upcurved, through-cutting, WL 14 cm, bite 3 x 4 mm  
**Nasenzange nach Wigand**, 45° aufgebogen, durchschneidend, NL 14 cm, Schnittgröße 3 x 4 mm



**234400FX** **Nasal Cutting Forceps by Wigand**, straight, through-cutting, large, WL 14 cm, bite 11.5 x 2.5 mm  
**Conchotom nach Wigand**, gerade, durchschneidend, groß, NL 14 cm, Schnittgröße 11,5 x 2,5 mm



**234400FX**

**234445FX**

**234500FX**

**234545FX**

**234400FX** straight, through-cutting, large / WL 14 cm, bite 11.5 x 2.5 mm  
gerade, durchschneidend, groß / NL 14 cm, Schnittgröße 11,5 x 2,5 mm

**234445FX** 30° upcurved, through-cutting, large / WL 14 cm, bite 11.5 x 2.5 mm  
30° aufgebogen, durchschneidend, groß / NL 14 cm, Schnittgröße 11,5 x 2,5 mm

**234500FX** straight, through-cutting, small / WL 14 cm, bite 6 x 2 mm  
gerade, durchschneidend, klein / NL 14 cm, Schnittgröße 6 x 2 mm

**234545FX** 30° upcurved, through-cutting, small / WL 14 cm, bite 6 x 2 mm  
30° aufgebogen, durchschneidend, klein / NL 14 cm, Schnittgröße 6 x 2 mm



**227100FX** **Nasal Forceps by Takahashi**, straight, WL 12.5 cm, spoon 10 x 2.5 mm  
**Nasenzange nach Takahashi**, gerade, NL 12,5 cm, Löffel 10 x 2,5 mm



**227100FX**

**227101FX**

**227102FX**

<b>227100FX</b>	straight / WL 12.5 cm, spoon 10 x 2.5 mm	gerade / NL 12,5 cm, Löffel 10 x 2,5 mm
<b>227101FX</b>	straight / WL 12.5 cm, spoon 10 x 3 mm	gerade / NL 12,5 cm, Löffel 10 x 3 mm
<b>227102FX</b>	45° upturned / WL 12.5 cm, spoon 10 x 3 mm	45° aufgebogen / NL 12,5 cm, Löffel 10 x 3 mm



**238101FX** Suction Forceps by Takahashi, straight, WL 10 cm, size 1 = 3.5 mm  
Saugzange nach Takahashi, gerade, NL 10 cm, Fig. 1 = 3,5 mm



**238101FX**

**238102FX**

**238201FX**

**238202FX**

<b>238101FX</b>	straight / WL 10 cm, size 1 = 3.5 mm	gerade / NL 10 cm, Fig. 1 = 3,5 mm
<b>238201FX</b>	30° upturned / WL 10 cm, size 1 = 3.5 mm	30° aufgebogen / NL 10 cm, Fig. 1 = 3,5 mm



**415604FXF**

**415604FXF** **Antrum Grasping Forceps**, 140-155° backbiter, jaws curved downward, WL 10 cm, with flush connector  
**Kieferhöhlenfasszange**, 140-155° rückwärts, Maul nach unten, NL 10 cm, mit Spülanschluss

**415600FX** 90-120° backbiter, jaws curved downward / WL 10 cm  
 90-120° rückwärts, Maulteil nach unten / NL 10 cm

**415600FXF** 90-120° backbiter, jaws curved downward / WL 10 cm, with flush connector  
 90-120° rückwärts, Maulteil nach unten / NL 10 cm, mit Spülanschluss

**415601FX** 90-120° backbiter, jaws curved upwards / WL 10 cm  
 90-120° rückwärts, Maulteil nach oben / NL 10 cm

**415602FX** 90-120° backbiter, jaws curved to right / WL 10 cm  
 90-120° rückwärts, Maulteil nach rechts / NL 10 cm

**415603FX** 90-120° backbiter, jaws curved to left / WL 10 cm  
 90-120° rückwärts, Maulteil nach links / NL 10 cm

**415604FX** 140-155° backbiter, jaws curved downward / WL 10 cm  
 140-155° rückwärts, Maul nach unten / NL 10 cm

**415604FXF** 140-155° backbiter, jaws curved downward / WL 10 cm, with flush connector  
 140-155° rückwärts, Maul nach unten / NL 10 cm, mit Spülanschluss

**415605FX** 115-140° backbiter, jaws curved downward / WL 10 cm  
 115-140° rückwärts, Maul nach unten / NL 10 cm

**415605FXF** 115-140° backbiter, jaws curved downward / WL 10 cm, with flush connector  
 115-140° rückwärts, Maul nach unten / NL 10 cm, mit Spülanschluss

**Sinus Surgery**  
**Nasennebenhöhlen**



**415610FX**

- 415610FX** **Antrum Grasping Forceps**, 90-120° backbiter, jaws curved downward, WL 10 cm, rotatable  
**Kieferhöhlenfasszange**, 90-120° rückwärts, Maulteil nach unten, NL 10 cm, drehbar
- 415630FX** **Antrum Grasping Forceps**, 90-120° backbiter, jaws curved downward, WL 13 cm, rotatable  
**Kieferhöhlenfasszange**, 90-120° rückwärts, Maulteil nach unten, NL 13 cm, drehbar



**235100FX** **Antrum Punch by Ostrum**, upside backwards, with flush connector, WL 10 cm, bite 2.5 mm  
**Antrumstanze nach Ostrum**, nach oben rückwärts, mit Spülanschluss, NL 10 cm, Ausschnitt 2,5 mm



**235101FX**

**235102FX**

**235100FX** upside backwards, with flush connector / WL 10 cm, bite 2.5 mm  
 nach oben rückwärts, mit Spülanschluss / NL 10 cm, Ausschnitt 2,5 mm

**235101FX** left backwards, with flush connector / WL 10 cm, bite 2.5 mm  
 nach links rückwärts, mit Spülanschluss / NL 10 cm, Ausschnitt 2,5 mm

**235102FX** right backwards, with flush connector / WL 10 cm, bite 2.5 mm  
 nach rechts rückwärts, mit Spülanschluss / NL 10 cm, Ausschnitt 2,5 mm

**Sinus Surgery**  
**Nasennebenhöhlen**



**235120FX** **Antrum Punch by Ostrum**, upside backwards, with flush connector, WL 10 cm, bite 1.5 mm  
**Antrumstanze nach Ostrum**, nach oben rückwärts, mit Spülanschluss, NL 10 cm, Ausschnitt 1,5 mm



**235120FX**

**235121FX**

**235122FX**

**235120FX** upside backwards, with flush connector / WL 10 cm, bite 1.5 mm  
 nach oben rückwärts, mit Spülanschluss / NL 10 cm, Ausschnitt 1,5 mm

**235121FX** left backwards, with flush connector / WL 10 cm, bite 1.5 mm  
 nach links rückwärts, mit Spülanschluss / NL 10 cm, Ausschnitt 1,5 mm

**235122FX** right backwards, with flush connector / WL 10 cm, bite 1.5 mm  
 nach rechts rückwärts, mit Spülanschluss / NL 10 cm, Ausschnitt 1,5 mm



**235110FX**



**235110FX**

**Antrum Punch by Ostrum**, rotatable, backw., with flush connector, WL 10 cm, bite 2.5 mm  
**Antrumstanze nach Ostrum**, drehbar, rückwärts, mit Spülanschluss, NL 10 cm, Ausschnitt 2,5 mm



**235111FX**



**235111FX**

**Antrum Punch by Ostrum**, rotatable, backw., with flush connector, WL 10 cm, bite 1.5 mm  
**Antrumstanze nach Ostrum**, drehbar, rückwärts, mit Spülanschluss, NL 10 cm, Ausschnitt 1,5 mm



**235115FX**



**235115FX**

**Antrum Punch**, rotatable, backward cutting, WL 10 cm, bite 1.5 mm  
**Antrumstanze**, drehbar, rückwärts schneidend, NL 10 cm, Ausschnitt 1,5 mm

**Sinus Surgery**  
**Nasennebenhöhlen**



**235125FX**

**235125FX** **Antrum Punch**, rotatable, backward cutting, WL 10 cm, bite 2.5 mm  
**Antrumstanze**, drehbar, rückwärts schneidend, NL 10 cm, Ausschnitt 2,5 mm

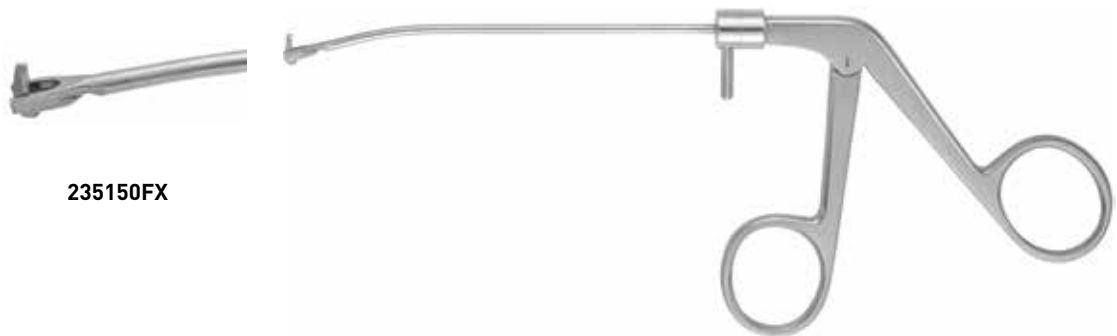

**235150FX**

**235150FX** **Antrum Punch by Tobey**, shaft curved, rotatable, backwards, WL 10 cm  
**Antrumstanze nach Tobey**, Schaft abgebogen, drehbar, rückwärts, NL 10 cm



**235200FX**

**235200FX** **Antrum Suction Punch**, straight, upside backward cutting, WL 10 cm, bite 2.5 mm  
**Antrum-Saugstanze**, gerade, nach oben rückwärts schneidend, NL 10 cm, Ausschnitt 2,5 mm

**235200FX** straight, upside backward cutting / WL 10 cm, bite 2.5 mm  
gerade, nach oben rückwärts schneidend / NL 10 cm, Ausschnitt 2,5 mm

**235201FX** straight, left side backward cutting / WL 10 cm, bite 2.5 mm  
gerade, nach links rückwärts schneidend / NL 10 cm, Ausschnitt 2,5 mm

**235202FX** straight, right side backward cutting / WL 10 cm, bite 2.5 mm  
gerade, nach rechts rückwärts schneidend / NL 10 cm, Ausschnitt 2,5 mm

**Sinus Surgery**  
**Nasennebenhöhlen**



**234902FXF**



**234901FXF** **Antrum Side-Biting Punch**, left side cutting, with flush connector, WL 10 cm  
**Antrum Seitwärtsstanze**, linksschneidend, mit Spülanschluss, NL 10 cm

**234902FXF** **Antrum Side-Biting Punch**, right side cutting, with flush connector, WL 10 cm  
**Antrum Seitwärtsstanze**, rechtsschneidend, mit Spülanschluss, NL 10 cm



**234904FX**



**234903FX** **Antrum Side-Biting Punch**, right side cutting, with flush connector, WL 13 cm  
**Antrum Seitwärtsstanze**, rechtsschneidend, mit Spülanschluss, NL 13 cm

**234904FX** **Antrum Side-Biting Punch**, left side cutting, with flush connector, WL 13 cm  
**Antrum Seitwärtsstanze**, linksschneidend, mit Spülanschluss, NL 13 cm



**230500FX**



**230500FX**

**Polyp Grasping Forceps by Wigand**, 60° upturned, WL 11 cm, spoon 6 x 14 mm  
**Polypenfasszange nach Wigand**, 60° aufgebogen, NL 11 cm, Löffel 6 x 14 mm

**Sinus Surgery**  
**Nasennebenhöhlen**



**234210FX**



**234210FX** **Polyp Forceps by Watson-Williams**, WL 11 cm, size 1  
**Polypenzange nach Watson-Williams**, NL 11 cm, Fig. 1

**234220FX** **Polyp Forceps by Watson-Williams**, WL 11 cm, size 2  
**Polypenzange nach Watson-Williams**, NL 11 cm, Fig. 2



**228100FX** **Nasal Cutting Forceps by Schmeden**, through-cutting, WL 12 cm, size 0  
**Conchotom nach Schmeden**, durchschneidend, NL 12 cm, Fig. 0

<b>228100FX</b>	through-cutting / WL 12 cm, size 0	durchschneidend / NL 12 cm, Fig. 0
<b>228101FX</b>	through-cutting / WL 12 cm, size 1	durchschneidend / NL 12 cm, Fig. 1
<b>228102FX</b>	through-cutting / WL 12 cm, size 2	durchschneidend / NL 12 cm, Fig. 2



**228100FX**



**228101FX**



**228102FX**



**229101FX**

**229101FX** **Nasal Cutting Forceps by Hartmann**, round, with grid, WL 11 cm, size 1  
**Conchotom nach Hartmann**, rund, mit Fanggitter, NL 11 cm, Fig. 1

**229101FX** round, with grid / WL 11 cm, size 1  
 rund, mit Fanggitter / NL 11 cm, Fig. 1



**229102FX** round, with grid / WL 11 cm, size 2  
 rund, mit Fanggitter / NL 11 cm, Fig. 2



**229103FX** round, with grid / WL 11 cm, size 3  
 rund, mit Fanggitter / NL 11 cm, Fig. 3



**229104FX** round, with grid / WL 11 cm, size 4  
 rund, mit Fanggitter / NL 11 cm, Fig. 4



**Sinus Surgery**  
**Nasennebenhöhlen**



**241100FX** **Forceps by Struempel**, straight, oval, fenestrated, WL 10 cm  
**Zängchen nach Strümpel**, gerade, oval, gefenstert, NL 10 cm



**241100FX**



**241145FX**



**241190FX**

<b>241100FX</b>	straight, oval, fenestrated / WL 10 cm	gerade, oval, gefenstert / NL 10 cm
<b>241145FX</b>	45° upturned, oval, fenestrated / WL 10 cm	45° aufgebogen, oval, gefenstert / NL 10 cm
<b>241190FX</b>	90° upturned, oval, fenestrated / WL 10 cm	90° aufgebogen, oval, gefenstert / NL 10 cm



**242100FX**



**242100FX** **Scissors by Bellucci**, straight, WL 10 cm  
**Schere nach Bellucci**, gerade, NL 10 cm



**238519FX** **Ethmoid Forceps by Draf**, straight, oval, fenestrated, WL 19 cm  
**Siebbeinzange nach Draf**, gerade, oval, gefenstert, NL 19 cm

<b>238513FX</b>	straight, oval, fenestrated / WL 13 cm	gerade, oval, gefenstert / NL 13 cm
<b>238516FX</b>	straight, oval, fenestrated / WL 16 cm	gerade, oval, gefenstert / NL 16 cm
<b>238519FX</b>	straight, oval, fenestrated / WL 19 cm	gerade, oval, gefenstert / NL 19 cm



**238613FX** **Ethmoid Forceps by Draf**, 60° upturned, oval, fenestrated, WL 13 cm  
**Siebbeinzange nach Draf**, 60° aufgebogen, oval, gefenstert, NL 13 cm

<b>238613FX</b>	60° upturned, oval, fenestrated / WL 13 cm	60° aufgebogen, oval, gefenstert / NL 13 cm
<b>238616FX</b>	60 ° upturned, oval, fenestrated / WL 16 cm	60° aufgebogen, oval, gefenstert / NL 16 cm
<b>238619FX</b>	60 ° upturned, oval, fenestrated / WL 19 cm	60° aufgebogen, oval, gefenstert / NL 19 cm

**Sinus Surgery**  
**Nasennebenhöhlen**



**238713FX**



**238713FX** **Ethmoid Forceps by Draf**, 90 ° upturned, oval, fenestrated, WL 13 cm  
**Siebbeinzange nach Draf**, 90° aufgebogen, oval, gefenstert, NL 13 cm

<b>238713FX</b>	90 ° upturned, oval, fenestrated / WL 13 cm	90° aufgebogen, oval, gefenstert / NL 13 cm
<b>238716FX</b>	90 ° upturned, oval fenestrated / WL 16 cm	90° aufgebogen, oval, gefenstert / NL 16 cm
<b>238719FX</b>	90 ° upturned, oval, fenestrated / WL 19 cm	90° aufgebogen, oval, gefenstert / NL 19 cm



**226570FX** **Nasal Spoon Forceps**, straight, round cup, Ø 2.5 mm, WL 18 cm  
**Nasenlöffelzange**, gerade, runder Löffel, Ø 2,5 mm, NL 18 cm

**Sinus Surgery**  
**Nasennebenhöhlen**



**238813FX** **Ethmoid Scissors by Draf**, straight, WL 13 cm  
**Siebbeinschere nach Draf**, gerade, NL 13 cm

**238816FX** **Ethmoid Scissors by Draf**, straight, WL 16 cm  
**Siebbeinschere nach Draf**, gerade, NL 16 cm



**226540FX** **Nasal Scissors**, straight, extra delicate, WL 19 cm  
**Nasenschere**, gerade, extra zart, NL 19 cm

<b>226540FX</b>	straight, extra delicate / WL 19 cm	gerade, extra zart / NL 19 cm
<b>226541FX</b>	curved left, extra delicate / WL 19 cm	nach links gebogen, extra zart / NL 19 cm
<b>226542FX</b>	curved right, extra delicate / WL 19 cm	nach rechts gebogen, extra zart / NL 19 cm
<b>226545FX</b>	45° curved up, extra delicate / WL 19 cm	45° aufgebogen, extra zart / NL 19 cm

**Sinus Surgery**  
**Nasennebenhöhlen**



**239101FX** **Micro Elevator by Draf**, slightly curved, 25 cm, width 1 mm  
**Mikro-Elevatorium nach Draf**, leicht gebogen, 25 cm, Breite 1 mm

<b>239101FX</b>	slightly curved / 25 cm, width 1 mm	leicht gebogen / 25 cm, Breite 1 mm
<b>239102FX</b>	slightly curved / 25 cm, width 3 mm	leicht gebogen / 25 cm, Breite 3 mm
<b>239103FX</b>	strongly curved / 25 cm, width 3 mm	stark gebogen / 25 cm, Breite 3 mm
<b>239104FX</b>	angled / 25 cm, width 4 mm	abgewinkelt / 25 cm, Breite 4 mm



**239301FX** **Round Knife by Draf**, straight, 19 cm, Ø 1.5 mm  
**Rundschnittmesser nach Draf**, gerade, 19 cm, Ø 1,5 mm

<b>239301FX</b>	straight / 19 cm, Ø 1.5 mm	gerade / 19 cm, Ø 1,5 mm
<b>239302FX</b>	bayonet-shaped / 19 cm, Ø 1.5 mm	bajonettförmig / 19 cm, Ø 1,5 mm
<b>239401FX</b>	45° angled, straight shaft / 19 cm, Ø 2 mm	45° abgewinkelt, gerader Schaft / 19 cm, Ø 2 mm
<b>239402FX</b>	bayonet-shaped / 19 cm, Ø 2 mm	bajonettförmig / 19 cm, Ø 2 mm
<b>239501FX</b>	straight, vertical cutting / 19 cm	gerade, vertikal schneidend / 19 cm
<b>239502FX</b>	bayonet-shaped, vertical cutting / 19 cm	bajonettförmig, vertikal schneidend / 19 cm



**418350FX** **Ring Curette by Cappabianca-de Divitiis**, lateral curved sheath end, sharp, Ø 3 mm  
**Ringkürette nach Cappabianca-de Divitiis**, Schaftende seitlich gebogen, scharf, Ø 3 mm

**418350FX** lateral curved sheath end, sharp / Ø 3 mm Schaftende seitlich gebogen, scharf / Ø 3 mm

**418351FX** lateral curved sheath end, sharp / Ø 5 mm Schaftende seitlich gebogen, scharf / Ø 5 mm

**418352FX** tip angled 45°, sharp / Ø 3 mm Spitze 45° gewinkelt, scharf / Ø 3 mm

**418353FX** tip angled 45°, sharp / Ø 5 mm Spitze 45° gewinkelt, scharf / Ø 5 mm



**419000FX** **Hook**, blunt, 90° angled, 19 cm, 0.5 mm  
**Häkchen**, stumpf, 90° abgewinkelt, 19 cm, 0,5 mm

**Sinus Surgery**  
**Nasennebenhöhlen**







**239003FX** **Dissector**, tip 45° angled, sharp, 24 cm, 3 mm  
**Dissektor**, Spitze 45° abgewinkelt, scharf, 24 cm, 3 mm







**239201FX** **Sickle Knife by Draf**, 19 cm  
**Sichelmesser nach Draf**, 19 cm

**Sinus Surgery**  
**Nasennebenhöhlen**

Length mm	Ø mm	Diamond, coarse	Diamond, fine	Round, stainless	Round, Tungsten carbide	Cross-Cut, Tungsten carbide
Länge mm	Ø mm	Diamant, grob	Diamant, fein	rund, rostfrei	rund, HM	Querhieb, HM
						
70	0.6	-	142106FX	136106FX	136206FX (9,5 mm)	-
70	0.7	-	142107FX	-	-	-
70	0.8	-	142108FX	136108FX	136208FX	-
70	1.0	-	142110FX	136110FX	136210FX	-
70	1.4	-	142114FX	136114FX	136214FX	136414FX
70	1.8	-	142118FX	136118FX	136218FX	-
70	2.1	-	142121FX	-	136221FX	-
70	2.3	142523FX	142123FX	136123FX	136223FX	136423FX
70	2.5	-	142125FX	-	-	-
70	2.7	142527FX	142127FX	136127FX	136227FX	-
70	3.1	142531FX	142131FX	136131FX	136231FX	136431FX
70	3.5	142535FX	142135FX	136135FX	136235FX	-
70	4.0	142540FX	142140FX	136140FX	136240FX	136440FX
70	4.5	142545FX	142145FX	136145FX	136245FX	-
70	5.0	142550FX	142150FX	136150FX	136250FX	136450FX
70	6.0	142560FX	142160FX	136160FX	136260FX	136460FX
70	6.5	-	-	-	-	-
70	7.0	142570FX	142170FX	136170FX	136270FX	-
-	-	-	-	-	-	-
95	0.6	-	250406FX	-	250806FX (0,5 mm)	-
95	0.8	-	-	-	250808FX	-
95	1.0	-	250410FX	-	250810FX	-
95	1.4	-	-	-	-	-
95	1.8	-	-	250318FX	250818FX	-
95	2.1	-	-	-	-	-
95	2.3	250723FX	250423FX	250323FX	250823FX	-
95	2.5	-	-	-	-	-
95	2.7	250727FX	250427FX	250327FX	-	-
95	3.1	250731FX	-	250331FX	250831FX	250931FX
95	3.5	-	250435FX	250335FX	250835FX	-
95	4.0	250740FX	250440FX	250340FX	250840FX	250940FX

**Sinus Surgery**  
**Nasennebenhöhlen**

Length mm	Ø mm	Diamond, coarse	Diamond, fine	Round, stainless	Round, Tungsten carbide	Cross-Cut, Tungsten carbide
Länge mm	Ø mm	Diamant, grob	Diamant, fein	rund, rostfrei	rund, HM	Querhieb, HM
						
95	4.5	-	250445FX	250345FX	250845FX	-
95	5.0	-	250450FX	250350FX	250850FX	250950FX
95	6.0	-	-	250360FX	250860FX	250960FX
95	6.5	-	-	-	-	-
95	7.0	-	250470FX	250370FX	250870FX	-
125	0.6	-	260406FX	-	-	-
125	0.8	-	-	-	-	-
125	1.0	-	260410FX	-	-	-
125	1.4	-	-	-	-	-
125	1.8	-	260418FX	260318FX	-	-
125	2.1	-	260421FX	-	-	-
125	2.3	-	260423FX	260323FX	260823FX	-
125	2.5	-	260425FX	-	-	-
125	2.7	-	260427FX	260327FX	-	-
125	3.1	-	260431FX	260331FX	260831FX	-
125	3.5	-	260435FX	260335FX	-	-
125	4.0	-	260440FX	-	260840FX	-
125	4.5	-	260445FX	-	-	-
125	5.0	-	-	-	260850FX	-
125	6.0	-	260460FX	-	260860FX	-
125	6.5	-	-	-	-	-
125	7.0	-	260470FX	-	260870FX	-

**Sinus Surgery**  
**Nasennebenhöhlen**



**829700FX** **Handpiece**, straight, with external cooling, for 7 cm burrs  
**Bohrhandstück**, gerade, mit externer Kühlung, für 7cm Bohrer

<b>829700FX</b>	straight, with external cooling / for 7 cm burrs	gerade, mit externer Kühlung / für 7cm Bohrer
<b>829720FX</b>	straight, with external cooling / for 9.5 cm burrs	gerade, mit externer Kühlung / für 9,5 cm Bohrer
<b>829750FX</b>	straight, with external cooling / for 12.5 cm burrs	gerade, mit externer Kühlung / für 12,5 cm Bohrer



**829800FX** **Handpiece**, angled, with external cooling, for 7 cm burrs  
**Bohrhandstück**, abgewinkelt, mit externer Kühlung, für 7 cm Bohrer

<b>829800FX</b>	angled, with external cooling / for 7 cm burrs	abgewinkelt, mit externer Kühlung / für 7 cm Bohrer
<b>829855FX</b>	angled, with external cooling / for 9.5 cm burrs	abgewinkelt, mit externer Kühlung / für 9,5 cm Bohrer
<b>829880FX</b>	angled, with external cooling / for 12.5 cm burrs	abgewinkelt, mit externer Kühlung / für 12,5 cm Bohrer

**Sinus Surgery**  
**Nasennebenhöhlen**



**397701FX** **Nasal Speculum by Killian**, for 118900FX, right blade shortened, 14 cm, blade length left 55 mm  
**Nasenspekulum nach Killian**, für 118900FX, rechtes Blatt gekürzt, 14 cm, Blattlänge links 55 mm



**397702FX** **Nasal Speculum by Killian**, for 118900FX, left blade shortened, 14 cm, blade length right 55 mm  
**Nasenspekulum nach Killian**, für 118900FX, linkes Blatt gekürzt, 14 cm, Blattlänge rechts 55 mm



**397705FX** **Nasal Speculum by Killian**, for 118900FX, right blade shortened, 14 cm, blade length left 75 mm  
**Nasenspekulum nach Killian**, für 118900FX, rechtes Blatt gekürzt, 14 cm, Blattlänge links 75 mm



**397706FX** **Nasal Speculum by Killian**, for 118900FX, left blade shortened, 14 cm, blade length right 75 mm  
**Nasenspekulum nach Killian**, für 118900FX, linkes Blatt gekürzt, 14 cm, Blattlänge rechts 75 mm



**041101FX** **Nasal Speculum by Hartmann-Halle**, 15.5 cm, blade length 29 mm, size 1  
**Nasenspekulum nach Hartmann-Halle**, 15,5 cm, Blattlänge 29 mm, Fig. 1

<b>041101FX</b>	15.5 cm, blade length 29 mm, size 1	15,5 cm, Blattlänge 29 mm, Fig. 1
<b>041102FX</b>	15.5 cm, blade length 33 mm, size 2	15,5 cm, Blattlänge 33 mm, Fig. 2
<b>041103FX</b>	15.5 cm, blade length 37 mm, size 3	15,5 cm, Blattlänge 37 mm, Fig. 3

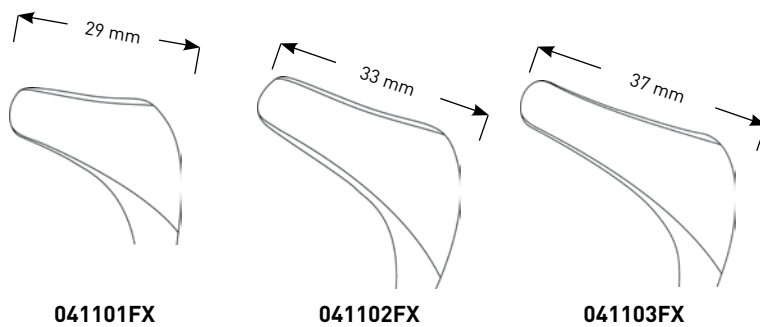



**041601FX** **Nasal Speculum by Hartmann**, 15 cm, blade length 27 mm, size 1  
**Nasenspekulum nach Hartmann**, 15 cm, Blattlänge 27 mm, Fig. 1

<b>041601FX</b>	15 cm, blade length 27 mm, size 1	15 cm, Blattlänge 27 mm, Fig. 1
<b>041602FX</b>	15 cm, blade length 30 mm, size 2	15 cm, Blattlänge 30 mm, Fig. 2
<b>041603FX</b>	15 cm, blade length 34 mm, size 3	15 cm, Blattlänge 34 mm, Fig. 3

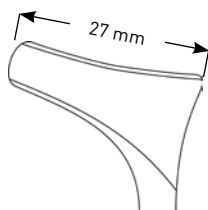

**041601FX**

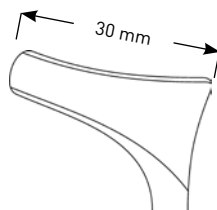

**041602FX**

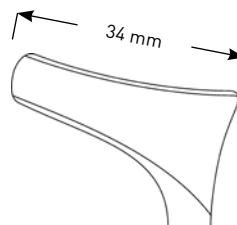

**041603FX**



**041701FX** **Nasal Speculum Model Vienna**, 14 cm, blade length 26 mm, size 1  
**Nasenspekulum Modell Wien**, 14 cm, Blattlänge 26 mm, Fig. 1

<b>041701FX</b>	14 cm, blade length 26 mm, size 1	14 cm, Blattlänge 26 mm, Fig. 1
<b>041702FX</b>	14 cm, blade length 29.5 mm, size 2	14 cm, Blattlänge 29,5 mm, Fig. 2
<b>041703FX</b>	14 cm, blade length 33 mm, size 3	14 cm, Blattlänge 33 mm, Fig. 3

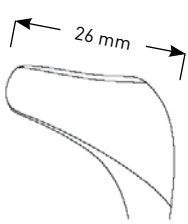

**041701FX**

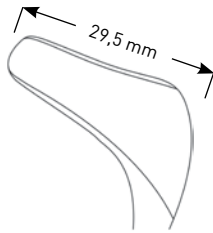

**041702FX**

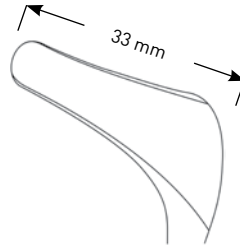

**041703FX**



**043101FX** **Nasal Speculum by Hartmann**, for adults, 13 cm, blade length 34 mm  
**Nasenspekulum nach Hartmann**, für Erwachsene, 13 cm, Blattlänge 34 mm

<b>043101FX</b>	for adults / 13 cm, blade length 34 mm	für Erwachsene / 13 cm, Blattlänge 34 mm
<b>043102FX</b>	for children / 13 cm, blade length 27 mm	für Kinder / 13 cm, Blattlänge 27 mm

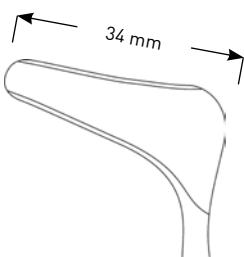

**043101FX**

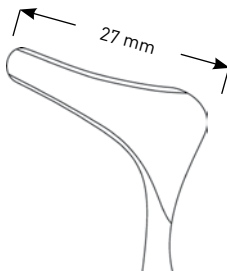

**043102FX**



**042001FX** **Nasal Speculum by Killian**, with set screw, 14 cm, blade length 40 mm, size 1  
**Nasenspekulum nach Killian**, mit Stellschraube, 14 cm, Blattlänge 40 mm, Fig. 1

<b>042001FX</b>	with set screw / 14 cm, blade length 40 mm, size 1	mit Stellschraube / 14 cm, Blattlänge 40 mm, Fig. 1
<b>042002FX</b>	with set screw / 14 cm, blade length 55 mm, size 2	mit Stellschraube / 14 cm, Blattlänge 55 mm, Fig. 2
<b>042003FX</b>	with set screw / 14 cm, blade length 75 mm, size 3	mit Stellschraube / 14 cm, Blattlänge 75 mm, Fig. 3
<b>042004FX</b>	with set screw / 14 cm, blade length 90 mm, size 4	mit Stellschraube / 14 cm, Blattlänge 90 mm, Fig. 4

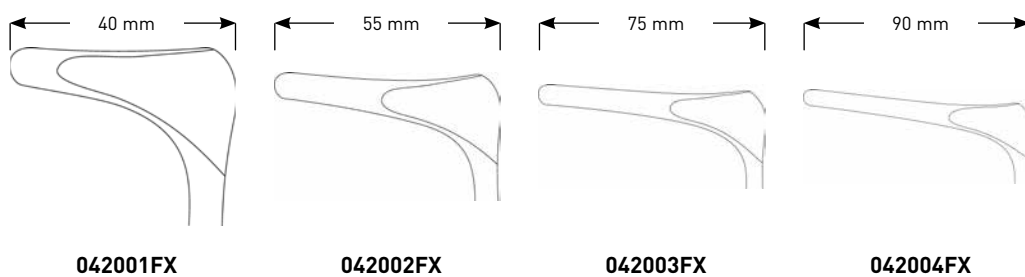



**042101FX** **Nasal Speculum by Killian, 14 cm, blade length 40 mm, size 1**  
**Nasenspekulum nach Killian, 14 cm, Blattlänge 40 mm, Fig. 1**

<b>042101FX</b>	14 cm, blade length 40 mm, size 1	14 cm, Blattlänge 40 mm, Fig. 1
<b>042102FX</b>	14 cm, blade length 55 mm, size 2	14 cm, Blattlänge 55 mm, Fig. 2
<b>042103FX</b>	14 cm, blade length 75 mm, size 3	14 cm, Blattlänge 75 mm, Fig. 3
<b>042104FX</b>	14 cm, blade length 90 mm, size 4	14 cm, Blattlänge 90 mm, Fig. 4

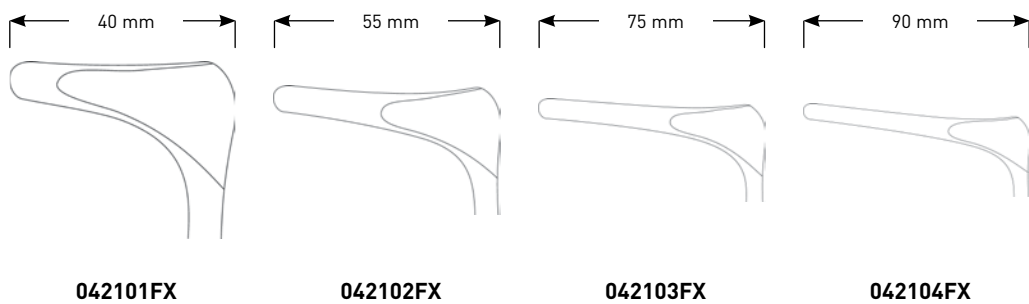



**300101FX** **Nasal Speculum by Cottle**, with set screw, 13 cm, size 1, blade length 35 mm  
**Nasenspekulum nach Cottle**, mit Stellschraube, 13 cm, Fig. 1, Blattlänge 35 mm

<b>300101FX</b>	with set screw / 13 cm, size 1, blade length 35 mm	mit Stellschraube / 13 cm, Fig. 1, Blattlänge 35 mm
<b>300102FX</b>	with set screw / 13 cm, size 2, blade length 50 mm	mit Stellschraube / 13 cm, Fig. 2, Blattlänge 50 mm
<b>300103FX</b>	with set screw / 13 cm, size 3, blade length 75 mm	mit Stellschraube / 13 cm, Fig. 3, Blattlänge 75 mm
<b>300104FX</b>	with set screw / 13 cm, size 4, blade length 90 mm	mit Stellschraube / 13 cm, Fig. 4, Blattlänge 90 mm

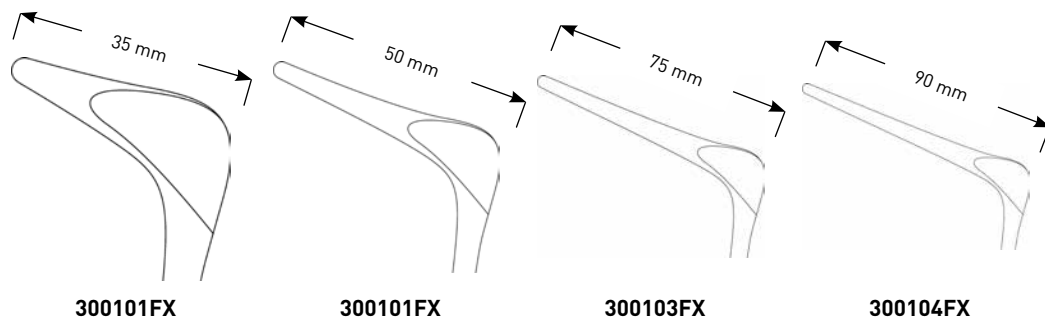



**300201FX** **Nasal Speculum by Cottle, 13 cm, size 1, blade length 35 mm**  
**Nasenspekulum nach Cottle, 13 cm, Fig. 1, Blattlänge 35 mm**

<b>300201FX</b>	13 cm, size 1, blade length 35 mm	13 cm, Fig. 1, Blattlänge 35 mm
<b>300202FX</b>	13 cm, size 2, blade length 50 mm	13 cm, Fig. 2, Blattlänge 50 mm
<b>300203FX</b>	13 cm, size 3, blade length 75 mm	13 cm, Fig. 3, Blattlänge 75 mm
<b>300204FX</b>	13 cm, size 4, blade length 90 mm	13 cm, Fig. 4, Blattlänge 90 mm

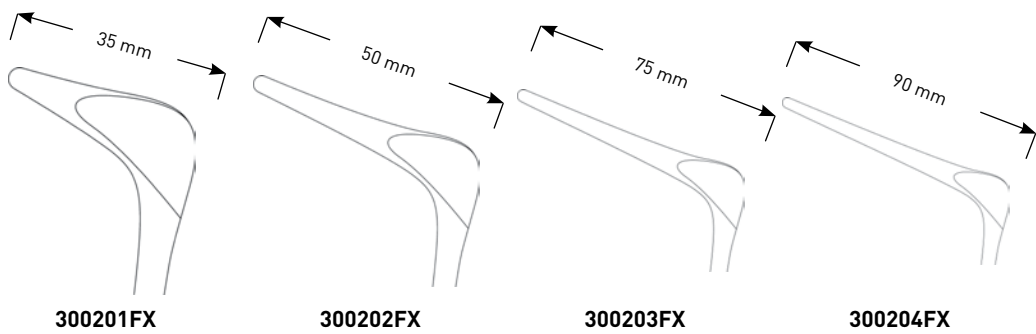

**Sinus Surgery**  
**Nasennebenhöhlen**



**402201FX** **Retractor by Middeldorpf**, 21.5 cm, size 14 x 17 mm  
**Wundhaken nach Middeldorpf**, 21,5 cm, Größe 14 x 17 mm

<b>402201FX</b>	21.5 cm, size 14 x 17 mm	21,5 cm, Größe 14 x 17 mm
<b>402202FX</b>	22 cm, size 20 x 22 mm	22 cm, Größe 20 x 22 mm
<b>402203FX</b>	23.5 cm, size 26 x 30 mm	23,5 cm, Größe 26 x 30 mm



**402601FX** **Retractor by Langenbeck**, 21 cm, size 35 x 7 mm  
**Wundhaken nach Langenbeck**, 21 cm, Größe 35 x 7 mm

<b>402601FX</b>	21 cm, size 35 x 7 mm	21 cm, Größe 35 x 7 mm
<b>402602FX</b>	21 cm, size 35 x 10 mm	21 cm, Größe 35 x 10 mm
<b>402603FX</b>	21 cm, size 35 x 15 mm	21 cm, Größe 35 x 15 mm
<b>402604FX</b>	21 cm, size 60 x 20 mm	21 cm, Größe 60 x 20 mm



**400112FX** **Lip Retractor by Sternberg, 12 cm**  
**Lippenretraktor nach Sternberg, 12 cm**

<b>400112FX</b>	12 cm	12 cm
<b>400114FX</b>	14 cm	14 cm
<b>400116FX</b>	16 cm	16 cm



**407312FX** **Spatula, malleable, 20 cm, width 12 mm**  
**Spatel, biegsam, 20 cm, Breite 12 mm**

**407317FX** **Spatula, malleable, 20 cm, width 17 mm**  
**Spatel, biegsam, 20 cm, Breite 17 mm**



**086108FX** Towel Forceps by Backhaus, 8 cm  
Tuchklemme nach Backhaus, 8 cm

<b>086108FX</b>	8 cm	8 cm
<b>086111FX</b>	11 cm	11 cm
<b>086113FX</b>	13 cm	13 cm

**Numerical Index**  
**Numerischer Index**

<b>Kat. Nr.</b>	<b>Seite</b>
<b>Cat. No.</b>	<b>Page</b>
032416FX	10
041101FX	90
041102FX	90
041103FX	90
041601FX	91
041602FX	91
041603FX	91
041701FX	92
041702FX	92
041703FX	92
042001FX	93
042002FX	93
042003FX	93
042004FX	93
042101FX	94
042102FX	94
042103FX	94
042104FX	94
043101FX	92
043102FX	92
049415FX	9
049418FX	9
049420FX	9
049702FX	10
049703FX	10
049704FX	10
049712FX	10
049713FX	10
049714FX	10
049802FX	11
049803FX	11
049804FX	11
086108FX	99
086111FX	99
086113FX	99
110106FX	11
110107FX	11
110108FX	11
110109FX	11
110110FX	11
110112FX	11
110115FX	11
110116FX	12
110118FX	12
110120FX	12
110122FX	12
110125FX	12
111106FX	12
111107FX	12
111108FX	12
111109FX	12
111110FX	12
111112FX	12
111115FX	12
111710FX	13
111810FX	13
136106FX	86
136108FX	86

<b>Kat. Nr.</b>	<b>Seite</b>
<b>Cat. No.</b>	<b>Page</b>
136110FX	86
136114FX	86
136118FX	86
136123FX	86
136127FX	86
136131FX	86
136135FX	86
136140FX	86
136145FX	86
136150FX	86
136160FX	86
136170FX	86
136206FX	86
136208FX	86
136210FX	86
136214FX	86
136218FX	86
136221FX	86
136223FX	86
136227FX	86
136231FX	86
136235FX	86
136240FX	86
136245FX	86
136250FX	86
136260FX	86
136270FX	86
136414FX	86
136423FX	86
136431FX	86
136440FX	86
136450FX	86
136460FX	86
142106FX	86
142107FX	86
142108FX	86
142110FX	86
142114FX	86
142118FX	86
142121FX	86
142123FX	86
142125FX	86
142127FX	86
142131FX	86
142135FX	86
142140FX	86
142145FX	86
142150FX	86
142160FX	86
142170FX	86
142523FX	86
142527FX	86
142531FX	86
142535FX	86
142540FX	86
142545FX	86
142550FX	86
142560FX	86

<b>Kat. Nr.</b>	<b>Seite</b>
<b>Cat. No.</b>	<b>Page</b>
142570FX	86
153700FX	27
201200FX	18
215100FX	19
215200FX	19
215215FX	19
226100FX	29
226109FX	29
226111FX	29
226200FX	29
226201FX	29
226202FX	29
226300FX	28
226300FXF	28
226301FX	28
226301FXF	28
226302FX	28
226302FXF	28
226303FX	28
226304FX	28
226400FX	29
226401FX	29
226402FX	29
226540FX	82
226541FX	82
226542FX	82
226545FX	82
226570FX	81
226901FX	51
226902FX	51
226903FX	51
226904FX	52
226905FX	53
226906FX	53
226908FX	54
226909FX	54
226910FX	55
226911FX	55
226912FX	56
226913FX	56
226914FX	57
226915FX	52
227100FX	66
227101FX	66
227102FX	66
227600FX	63
228100FX	77
228101FX	77
228102FX	77
228601FX	64
228602FX	64
228603FX	64
229101FX	78
229102FX	78
229103FX	78
229104FX	78
230100FX	58
230101FX	58

<b>Kat. Nr.</b>	<b>Seite</b>
<b>Cat. No.</b>	<b>Page</b>
230102FX	58
230103FX	58
230104FX	58
230140FX	60
230141FX	60
230142FX	60
230200FX	58
230201FX	58
230202FX	58
230203FX	58
230204FX	58
230240FX	60
230241FX	60
230242FX	60
230300FX	58
230301FX	58
230302FX	58
230303FX	58
230340FX	60
230341FX	60
230342FX	60
230500FX	76
230600FX	61
230700FX	61
231601FX	59
231602FX	59
231603FX	59
231701FX	59
231702FX	59
231801FX	59
231802FX	59
234210FX	77
234220FX	77
234300FX	64
234345FX	64
234400FX	65
234445FX	65
234500FX	65
234545FX	65
234603FX	35
234606FX	35
234835FX	36
234845FX	36
234865FX	36
234866FX	36
234901FXF	75
234902FXF	75
234903FX	75
234904FX	75
235035FX	39
235035FXF	39
235036FXF	37
235045FX	39
235045FXF	39
235046FXF	37
235065FX	39
235065FXF	39
235066FXF	38

# Numerical Index

## Numerischer Index

Kat. Nr. Cat. No.	Seite Page	Kat. Nr. Cat. No.	Seite Page	Kat. Nr. Cat. No.	Seite Page	Kat. Nr. Cat. No.	Seite Page
235075FX	39	236304FXF	41	250323FX	86	260840FX	87
235075FXF	39	236311FX	40	250327FX	86	260850FX	87
235076FXF	38	236312FX	40	250331FX	86	260860FX	87
235100FX	70	236313FX	40	250335FX	86	260870FX	87
235101FX	70	236314FX	40	250340FX	86	300101FX	95
235102FX	70	236333FX	40	250345FX	87	300102FX	95
235110FX	72	236334FX	40	250350FX	87	300103FX	95
235111FX	72	236343FX	40	250360FX	87	300104FX	95
235115FX	72	236344FX	40	250370FX	87	300201FX	96
235120FX	71	236500FX	47	250406FX	86	300202FX	96
235121FX	71	236501FX	47	250410FX	86	300203FX	96
235122FX	71	236502FX	47	250423FX	86	300204FX	96
235125FX	73	236600FX	48	250427FX	86	305100FX	19
235150FX	73	236601FX	48	250435FX	86	305900FX	19
235200FX	74	236602FX	48	250440FX	86	360100FX	20
235201FX	74	236702FX	50	250445FX	87	397701FX	89
235202FX	74	236703FX	50	250450FX	87	397702FX	89
235210FX	44	236704FX	50	250470FX	87	397705FX	89
235211FX	44	236712FX	50	250723FX	86	397706FX	90
235214FX	44	236901FX	61	250727FX	86	400112FX	98
235224FX	44	237001FX	62	250731FX	86	400114FX	98
235270FX	45	238101FX	67	250740FX	86	400116FX	98
235270FXF	45	238201FX	67	250806FX	86	402201FX	97
235271FX	45	238513FX	80	250808FX	86	402202FX	97
235271FXF	45	238516FX	80	250810FX	86	402203FX	97
235300FX	49	238519FX	80	250818FX	86	402601FX	97
235501FX	42	238613FX	80	250823FX	86	402602FX	97
235501FXF	42	238616FX	80	250831FX	86	402603FX	97
235502FX	42	238619FX	80	250835FX	86	402604FX	97
235502FXF	42	238713FX	81	250840FX	86	403101FX	26
235503FX	42	238716FX	81	250845FX	87	403102FX	26
235504FX	42	238719FX	81	250850FX	87	403103FX	26
235505FX	43	238813FX	82	250860FX	87	403104FX	26
235505FXF	43	238816FX	82	250870FX	87	403105FX	27
235506FX	43	239003FX	85	250931FX	86	403106FX	27
235506FXF	43	239101FX	83	250940FX	86	404100FX	25
235507FX	43	239102FX	83	250950FX	87	406101FX	25
235508FX	43	239103FX	83	250960FX	87	406102FX	25
235508FXF	43	239104FX	83	260318FX	87	406103FX	25
235509FX	43	239201FX	85	260323FX	87	407125FX	21
235509FXF	43	239301FX	83	260327FX	87	407130FX	21
235510FX	43	239302FX	83	260331FX	87	407140FX	21
235510FXF	43	239401FX	83	260335FX	87	407150FX	21
235513FX	42	239402FX	83	260406FX	87	407312FX	98
235513FXF	42	239501FX	83	260410FX	87	407317FX	98
235514FX	42	239502FX	83	260418FX	87	411100FX	22
235514FXF	42	241100FX	79	260421FX	87	411200FX	22
235901FX	62	241145FX	79	260423FX	87	412101FX	32
236000FX	63	241190FX	79	260425FX	87	412102FX	32
236001FX	63	242100FX	79	260427FX	87	412301FX	32
236002FX	63	250106FX	13	260431FX	87	412302FX	32
236301FX	41	250108FX	13	260435FX	87	412401FX	32
236301FXF	41	250110FX	13	260440FX	87	412402FX	32
236302FX	41	250112FX	13	260445FX	87	412502FX	30
236302FXF	41	250115FX	13	260460FX	87	412503FX	30
236303FX	41	250220FX	14	260470FX	87	412600FX	33
236303FXF	41	250221FX	14	260823FX	87	412601FX	33
236304FX	41	250318FX	86	260831FX	87	412702FX	34

**Numerical Index**  
**Numerischer Index**

<b>Kat. Nr.</b>	<b>Seite</b>
<b>Cat. No.</b>	<b>Page</b>
412703FX	34
413001FX	31
413002FX	31
413003FX	31
413004FX	31
413021FX	31
413022FX	31
413023FX	31
413024FX	31
413100FX	33
413200FX	34
413402FX	31
413403FX	31
413404FX	31
415100FX	45
415105FX	46
415170FX	46
415210FX	46
415600FX	68
415600FXF	68
415601FX	68
415602FX	68
415603FX	68
415604FX	68
415604FXF	68
415605FX	68
415605FXF	68
415610FX	69
415630FX	69
418100FX	22
418101FX	23
418102FX	23
418103FX	23
418201FX	23
418202FX	23
418203FX	23
418204FX	24
418205FX	24
418303FX	25
418304FX	25
418350FX	84
418351FX	84
418352FX	84
418353FX	84
418401FX	27
418402FX	27
418403FX	27
418404FX	27
418500FX	9
418600FX	9
418603FX	9
418604FX	9
418719FX	20
418825FX	20
418826FX	21
419000FX	84
726504FX	17
726506FX	17

<b>Kat. Nr.</b>	<b>Seite</b>
<b>Cat. No.</b>	<b>Page</b>
726508FX	17
726516FX	17
728100FX	6
728130FX	6
728170FX	6
728200FX	6
728230FX	6
728270FX	6
728500FX	6
728530FX	6
728570FX	6
730100FX	7
730116FX	15
730119FX	15
730130FX	7
730145FX	7
731116FX	15
731119FX	15
732116FX	15
732119FX	15
741116FX	15
741119FX	15
741200FX	8
742116FX	15
742119FX	15
750100FX	7
750130FX	7
750145FX	7
750170FX	7
750861FX	16
761116FX	16
761119FX	16
762119FX	16
829700FX	88
829720FX	88
829750FX	88
829800FX	88
829855FX	88
829880FX	88
863100FX	8
863101FX	8
863110FX	8

<b>Kat. Nr.</b>	<b>Seite</b>
<b>Cat. No.</b>	<b>Page</b>

<b>Kat. Nr.</b>	<b>Seite</b>
<b>Cat. No.</b>	<b>Page</b>

**Numerical Index**  
**Numerischer Index**

<b>Kat. Nr.</b>	<b>Seite</b>
<b>Cat. No.</b>	<b>Page</b>

<b>Kat. Nr.</b>	<b>Seite</b>
<b>Cat. No.</b>	<b>Page</b>

<b>Kat. Nr.</b>	<b>Seite</b>
<b>Cat. No.</b>	<b>Page</b>

<b>Kat. Nr.</b>	<b>Seite</b>
<b>Cat. No.</b>	<b>Page</b>

Author / Description	Page
Antifog solution "ULTRA STOP" . . . . .	8
Antrum Cannula by Van Eicken . . . . .	10, 11
Antrum Curette . . . . .	23, 25
Antrum Curette by Coakley . . . . .	26, 27
Antrum Curette by Faulkner . . . . .	25
Antrum Elevator by Sewall . . . . .	22
Antrum Grasping Forceps . . . . .	68, 69
Antrum Punch . . . . .	72, 73
Antrum Punch by Beyer . . . . .	33
Antrum Punch by Ostrum . . . . .	70, 71, 72
Antrum Punch by Tobey . . . . .	73
Antrum Side-Biting Punch . . . . .	75
Antrum Suction Punch . . . . .	74
Antrum Trocar Needle by Lichtwitz . . . . .	9
Biopsy and Grasping Forceps . . . . .	45, 46
Bipolar Cable . . . . .	17
Bipolar Forceps . . . . .	15, 16
Bone Punch . . . . .	30
Burr . . . . .	86, 87
Chisel by West . . . . .	22
Circular Cutting Punch . . . . .	35, 36, 39
Circular Cutting Punch (Gear Type) . . . . .	37, 38
Dissector . . . . .	85
Double Spoon Forceps . . . . .	42, 43, 44, 45
Ear Dressing Forceps by Jansen . . . . .	10
Elevator by Freer . . . . .	19
Ethmoid Forceps by Draf . . . . .	80, 81
Ethmoid Scissors by Draf . . . . .	82
Forceps by Struempel . . . . .	79
Frontal Sinus Bougie by Ritter-Halle . . . . .	21
Frontal Sinus Curette . . . . .	24
Frontal Sinus Punch . . . . .	34, 40, 41
Frontal Sinus Seeker by Castelnuovo . . . . .	20
Frontal Sinus Seeker by Kuhn . . . . .	21
Gouge by West . . . . .	22
Handpiece . . . . .	88
Hi-View Telescope . . . . .	6, 7
Hook . . . . .	84
Lip Retractor by Sternberg . . . . .	98
Maxillary Biopsy Forceps . . . . .	46
Maxillary Sinus Seeker . . . . .	20
Micro Elevator by Draf . . . . .	83
Nasal Cutting Forceps by Gruenwald-Henke . . . . .	64
Nasal Cutting Forceps by Hartmann . . . . .	78
Nasal Cutting Forceps by Schmeden . . . . .	77
Nasal Cutting Forceps by Struycken . . . . .	63
Nasal Cutting Forceps by Wigand . . . . .	65
Nasal Forceps . . . . .	51, 52, 54, 55, 56, 57
Nasal Forceps by Blakesley . . . . .	58, 59, 60, 61, 62, 63
Nasal Forceps by Blakesley-Wilde . . . . .	58
Nasal Forceps by Takahashi . . . . .	66
Nasal Forceps by Wigand . . . . .	64
Nasal Scissors . . . . .	28, 29, 82
Nasal Scissors by Heymann . . . . .	29
Nasal Speculum by Cottle . . . . .	95, 96
Nasal Speculum by Hartmann . . . . .	91, 92
Nasal Speculum by Hartmann-Halle . . . . .	90
Nasal Speculum by Killian . . . . .	89, 90, 93, 94

Author / Description	Page
Nasal Speculum Model Vienna . . . . .	92
Nasal Spoon Forceps . . . . .	52, 53, 54, 81
Polyp Forceps by Watson-Williams . . . . .	77
Polyp Grasping Forceps by Wigand . . . . .	76
Protection Tube . . . . .	8
Retractor by Langenbeck . . . . .	97
Ring Curette by Cappabianca-de Divitiis . . . . .	84
Round Knife by Draf . . . . .	83
S-Bite Nasal Forceps . . . . .	47, 48, 50
Scissors by Bellucci . . . . .	79
Septum Needle . . . . .	18
Sickle Knife . . . . .	27
Sickle Knife by Draf . . . . .	85
Sickle Knife by Plester . . . . .	27
Sinuscopy Trocar . . . . .	9
Spatula . . . . .	98
Sphenoid Punch by FS-Kerrison . . . . .	31
Sphenoid Punch by Hajek-Kofler . . . . .	32, 33
Sphenoid Punch by McKenty . . . . .	34
Suction Elevator by Gorney . . . . .	19
Suction Elevator by Guillen . . . . .	20
Suction Forceps by Blakesley . . . . .	61, 62
Suction Forceps by Gruenwald . . . . .	49
Suction Forceps by Takahashi . . . . .	67
Suction Tube by Frank-Pasquini . . . . .	14
Suction Tube by Frazier . . . . .	11, 12, 13
Towel Forceps by Backhaus . . . . .	99

Author / Description	Page
----------------------	------

Author / Description	Page
----------------------	------

Autor / Beschreibung	Seite
Antibesclagmittel „ULTRA STOP“	8
Antrum Seitwärtsstanze	75
Antrum-Kürette	25
Antrum-Saugstanze	74
Antrumlöffel	23
Antrumstanze	72, 73
Antrumstanze nach Ostrum	70, 71, 72
Antrumstanze nach Tobey	73
Bipolare Pinzette	15, 16
Bipolares HF Kabel	17
Bohrer	86, 87
Bohrhandstück	88
Conchotom nach Grünwald-Henke	64
Conchotom nach Hartmann	78
Conchotom nach Schmeden	77
Conchotom nach Struycken	63
Conchotom nach Wigand	65
Dissektor	85
Doppelevatorium nach Freer	19
Doppellöffel-Zange	42, 43, 44, 45
Flachmeißel nach West	22
Häkchen	84
Hi-View Optik	6, 7
Hohlmeißel nach West	22
Keilbeinstanze nach McKenty	34
Kieferhöhlen Probeexzisionszange	46
Kieferhöhlen-Elevatorium nach Sewall	22
Kieferhöhlenfazzange	68, 69
Kieferhöhlenkürette nach Coakley	26, 27
Kieferhöhlenkürette nach Faulkner	25
Kieferhöhlenpunktionsnadel n. Lichtwitz	9
Kieferhöhlensonde	20
Kieferhöhlenstanze nach Beyer	33
Knochenstanze	30
Knochenstanze nach FS-Kerrison	31
Knochenstanze nach Hajek-Kofler	32, 33
Lippenretraktor nach Sternberg	98
Mikro-Elevatorium nach Draf	83
Nasenlöffelzange	52, 53, 54, 81
Nasenschere	28, 29, 82
Nasenschere nach Heymann	29
Nasenspekulum Modell Wien	92
Nasenspekulum nach Cottle	95, 96
Nasenspekulum nach Hartmann	91, 92
Nasenspekulum nach Hartmann-Halle	90
Nasenspekulum nach Killian	89, 90, 93, 94
Nasenzange	51, 52, 54, 55, 56, 57
Nasenzange nach Blakesley	58, 59, 60, 61, 62, 63
Nasenzange nach Blakesley-Wilde	58
Nasenzange nach Takahashi	66
Nasenzange nach Wigand	64
Ohrpinzette nach Jansen	10
Polypenfazzange nach Wigand	76
Polypenzange nach Watson-Williams	77
Probeexzisions- und Fazzange	45, 46
Ringkürette nach Cappabianca-de Divitiis	84
Rundkopfstanze	35, 36, 39
Rundkopfstanze (Zahnradmechanik)	37, 38

Autor / Beschreibung	Seite
Rundschnittmesser nach Draf	83
S-Bite Nasenzange	47, 48, 50
Saugelevatorium nach Gorney	19
Saugelevatorium nach Guillen	20
Saugkanüle nach Frazier	13
Saugrohr nach Frank-Pasquini	14
Saugrohr nach Frazier	11, 12
Saugrohr nach Kahn-Frazier	13
Saugzange nach Blakesley	61, 62
Saugzange nach Grünwald	49
Saugzange nach Takahashi	67
Schere nach Bellucci	79
Schutzhülse	8
Septumkanüle	18
Sichelmesser	27
Sichelmesser nach Draf	85
Sichelmesser nach Plester	27
Siebbeinschere nach Draf	82
Siebbeinzange nach Draf	80, 81
Sinuskopie-Trokar	9
Spatel	98
Spülröhrchen nach Van Eicken	10, 11
Stirnhöhlen-Stanze	40, 41
Stirnhöhlenbougie nach Ritter-Halle	21
Stirnhöhlenlöffel	24
Stirnhöhlensonde nach Castelnuovo	20
Stirnhöhlensonde nach Kuhn	21
Stirnhöhlenstanze	34
Tuchklemme nach Backhaus	99
Wundhaken nach Langenbeck	97
Zängchen nach Strümpel	79

Autor / Beschreibung	Seite
----------------------	-------

Autor / Beschreibung	Seite
----------------------	-------

**FENTEX***medical* GmbH

take-off GewerbePark 2  
D-78579 Neuhausen ob Eck

Tel. +49 (0) 7467 - 949 62 0  
Fax +49 (0) 7467 - 949 62 17  
info@fentexmedical.com  
www.fentexmedical.com

**FENTEX** *Instruments · Made in Germany*

© FENTEXmedical GmbH · 2026 · Art.-Nr 003FX

