

Precision meets Quality

Rhinology
Rhinologie

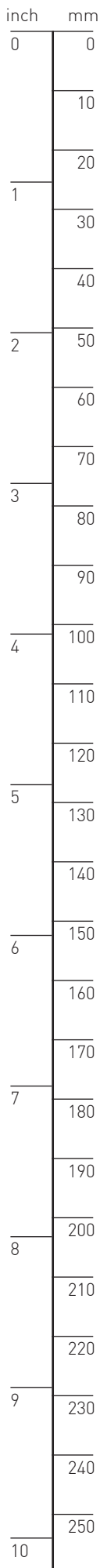

Edition 2026

The content of this catalogue is the literary property of FENTEX medical GmbH. The reproduction, translation or partial utilization of information is not permitted without prior written authorization from FENTEX medical.

All products shown in this catalogue carry a CE mark and are certified for distribution within the appropriate markets. Please note that some international markets have special certification requirements and that restrictions may apply. Information is available from FENTEX medical upon request.

Please refer to the current version of our general terms and conditions as well as the latest price list for further information on product availability and shipment terms.

We continuously strive to improve and update our products, to always meet or excel our customer's expectations and thus reserve the right to make alterations to our products without prior notice.



FENTEXmedical GmbH is certified according to EN ISO 13485:2016 / A11:2021 and directive 93/42/EEC.

Katalogausgabe 2026

Der Inhalt des vorliegenden Kataloges ist das geistige Eigentum der Firma FENTEX medical GmbH. Reproduktionen, Übersetzungen oder auch die teilweise Verwertung von Informationen hieraus sind untersagt bzw. nur nach vorheriger schriftlicher Genehmigung durch die FENTEX GmbH erlaubt.

Bei Verstößen oder Missbrauch behalten wir uns rechtliche Schritte vor. Die Produkte tragen das CE Zeichen und sind damit für dessen Geltungsbereich zugelassen. Für einzelne geografische Märkte kann eine gesonderte Registrierung bzw. Zertifizierung notwendig sein. Informationen dazu werden auf Anfrage mitgeteilt.

Darüber hinaus gelten die Allgemeinen Geschäftsbedingungen der FENTEX Medical GmbH in der jeweils gültigen Fassung, sowie die jeweils aktuelle Preisliste.

Bitte beachten Sie, dass es in Einzelfällen zu leichten Maßabweichungen kommen kann, die aber die grundlegende Funktion der Produkte nicht beeinträchtigen. Modelländerungen vorbehalten.



FENTEXmedical GmbH ist zertifiziert nach EN ISO 13485:2016 / A11:2021 und der Richtlinie 93/42/EWG.

Contact Details

Kontaktinformationen

FENTEXmedical GmbH
take-off GewerbePark 2
D-78579 Neuhausen ob Eck
Germany

Tel. +49 (0) 7467 - 949 62 0
Fax +49 (0) 7467 - 949 62 17

info@fentexmedical.com
www.fentexmedical.com

PRECISION MEETS QUALITY

FENTEXmedical GmbH is a medical company specializing in manufacturing and marketing of surgical instruments and endoscopy systems for ENT and Head & Neck surgeons.

Especially in this part of the human body with its anatomical and functional complexity and high aesthetic demands special skills are required. It is our mission not only to meet but to surpass these requirements with our products and services.

PRECISION MEETS QUALITY

FENTEXmedical GmbH ist ein Unternehmen, das sich auf die Entwicklung, Produktion und den Vertrieb chirurgischer Instrumente und Endoskopiesysteme für die Hals- Nasen und Ohrenheilkunde spezialisiert hat.

Gerade in diesem Bereich des menschlichen Körpers sind aufgrund der anatomischen und funktionalen Komplexität sowie der hohen ästhetischen Anforderungen besondere Qualitäten gefordert. Es ist unsere Mission, diese Qualitätsanforderungen mit unseren Produkten und Dienstleistungen nicht nur zu erfüllen sondern zu übertreffen.

Precision

We maintain a close cooperation with all of the medical specialists involved in head & neck surgery, including ENT-, Otolaryngologists and Plastic Surgeons. This cooperation allows us to precisely adapt the instrument and match it with the requirements of a particular operational technique. It also ensures that the latest developments are being consistently incorporated into our products. Together with our superior design and finishing we help to ensure your surgical achievements.

Präzision

Wir pflegen die enge Kooperation mit Spezialisten aller im Kopf- und Halsbereich tätigen chirurgischen Disziplinen. Dadurch können wir Ihnen für jede Indikation das passende Instrument bereitstellen und halten unser gesamtes Sortiment auf dem aktuellen Stand der medizinischen Entwicklung. Die Präzision in der Ausführung der Instrumente sichert Ihnen den Operationserfolg.

Customer Orientation

We market our products world wide through highly qualified specialist dealers thus achieving a maximum in local customer-service and -support. Our organisation is open to suggestions from clinical users and demand for custom made devices.

Kundenorientierung

Wir vertreiben unsere Produkte weltweit durch ein fachlich versiertes Händlernetz und erreichen dadurch ein Maximum in der Kundenbetreuung vor Ort. Darüber hinaus sind wir auch jederzeit ansprechbar im Hinblick auf die Sonderwünsche unserer Kunden.



040100FX **Nasal Speculum by Tieck-Halle, for babies, 13 cm, blade length 17.5 mm**
Nasenspekulum nach Tieck-Halle, für Kleinkinder, 13 cm, Blattlänge 17,5 mm

040100FX	for babies / 13 cm, blade length 17.5 mm	für Kleinkinder / 13 cm, Blattlänge 17,5 mm
040110FX	for children / 14 cm, blade length 21 mm	für Kinder / 14 cm, Blattlänge 21 mm

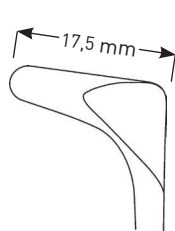

040100FX

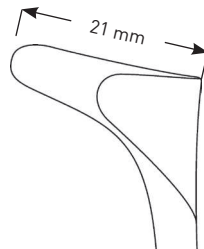

040110FX



041101FX **Nasal Speculum by Hartmann-Halle, 15.5 cm, blade length 29 mm, size 1**
Nasenspekulum nach Hartmann-Halle, 15,5 cm, Blattlänge 29 mm, Fig. 1

041101FX	15.5 cm, blade length 29 mm, size 1	15,5 cm, Blattlänge 29 mm, Fig. 1
041102FX	15.5 cm, blade length 33 mm, size 2	15,5 cm, Blattlänge 33 mm, Fig. 2
041103FX	15.5 cm, blade length 37 mm, size 3	15,5 cm, Blattlänge 37 mm, Fig. 3

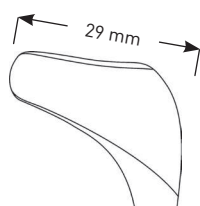

041101FX

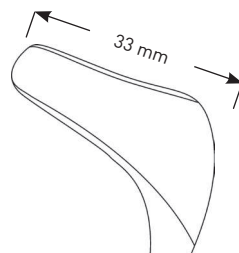

041102FX

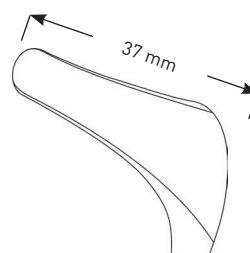

041103FX



041401FX **Nasal Speculum by Thudichum, small, 6.5 cm**
Nasenspekulum nach Thudichum, klein, 6,5 cm

041401FX	small / 6.5 cm	klein / 6,5 cm
041402FX	medium / 6.5 cm	mittel / 6,5 cm
041403FX	large / 6.5 cm	groß / 6,5 cm

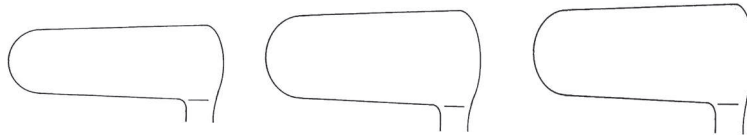

041401FX

041402FX

041403FX



041601FX **Nasal Speculum by Hartmann**, 15 cm, blade length 27 mm, size 1
Nasenspekulum nach Hartmann, 15 cm, Blattlänge 27 mm, Fig. 1

041601FX	15 cm, blade length 27 mm, size 1	15 cm, Blattlänge 27 mm, Fig. 1
041602FX	15 cm, blade length 30 mm, size 2	15 cm, Blattlänge 30 mm, Fig. 2
041603FX	15 cm, blade length 34 mm, size 3	15 cm, Blattlänge 34 mm, Fig. 3

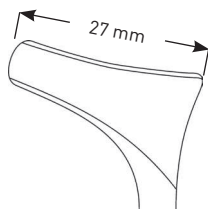

041601FX

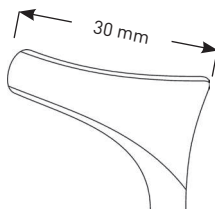

041602FX

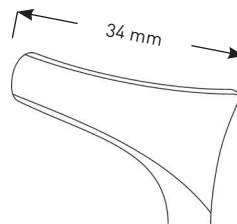

041603FX



041701FX **Nasal Speculum Model Vienna**, 14 cm, blade length 26 mm, size 1
Nasenspekulum Modell Wien, 14 cm, Blattlänge 26 mm, Fig. 1

041701FX	14 cm, blade length 26 mm, size 1	14 cm, Blattlänge 26 mm, Fig. 1
041702FX	14 cm, blade length 29.5 mm, size 2	14 cm, Blattlänge 29,5 mm, Fig. 2
041703FX	14 cm, blade length 33 mm, size 3	14 cm, Blattlänge 33 mm, Fig. 3

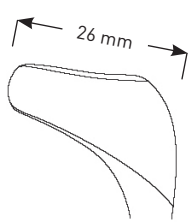

041701FX

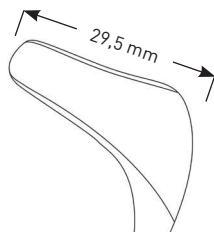

041702FX

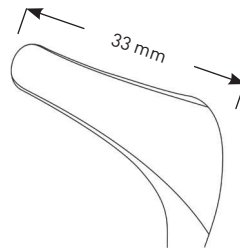

041703FX



041801FX **Nasal Speculum by Beckmann**, 15 cm, blade length 22 mm, Size 1
Nasenspekulum nach Beckmann, 15 cm, Blattlänge 22 mm, Fig. 1

041801FX 15 cm, blade length 22 mm, Size 1
15 cm, Blattlänge 22 mm, Fig. 1

041802FX 15 cm, blade length 25 mm, Size 2
15 cm, Blattlänge 25 mm, Fig. 2

041803FX 15 cm, blade length 29 mm, Size 3
15 cm, Blattlänge 29 mm, Fig. 3



043101FX **Nasal Speculum by Hartmann**, for adults, 13 cm, blade length 34 mm
Nasenspekulum nach Hartmann, für Erwachsene, 13 cm, Blattlänge 34 mm

043101FX for adults / 13 cm, blade length 34 mm für Erwachsene / 13 cm, Blattlänge 34 mm

043102FX for children / 13 cm, blade length 27 mm für Kinder / 13 cm, Blattlänge 27 mm

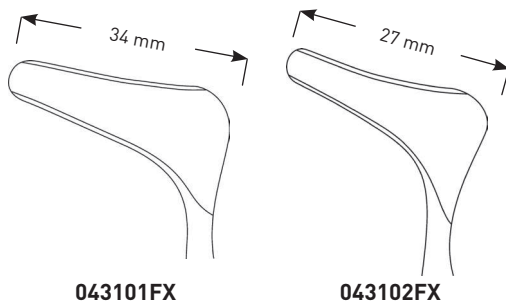



042001FX **Nasal Speculum by Killian**, with set screw, 14 cm, blade length 40 mm, size 1
Nasenspekulum nach Killian, mit Stellschraube, 14 cm, Blattlänge 40 mm, Fig. 1

042001FX	with set screw / 14 cm, blade length 40 mm, size 1	mit Stellschraube / 14 cm, Blattlänge 40 mm, Fig. 1
042002FX	with set screw / 14 cm, blade length 55 mm, size 2	mit Stellschraube / 14 cm, Blattlänge 55 mm, Fig. 2
042003FX	with set screw / 14 cm, blade length 75 mm, size 3	mit Stellschraube / 14 cm, Blattlänge 75 mm, Fig. 3
042004FX	with set screw / 14 cm, blade length 90 mm, size 4	mit Stellschraube / 14 cm, Blattlänge 90 mm, Fig. 4

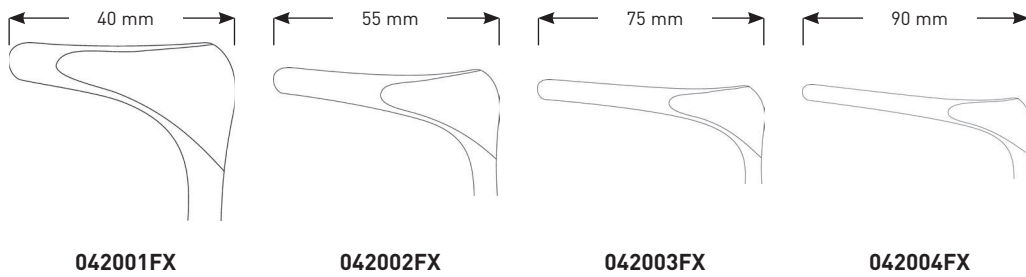



042101FX **Nasal Speculum by Killian**, 14 cm, blade length 40 mm, size 1
Nasenspekulum nach Killian, 14 cm, Blattlänge 40 mm, Fig. 1

042101FX	14 cm, blade length 40 mm, size 1	14 cm, Blattlänge 40 mm, Fig. 1
042102FX	14 cm, blade length 55 mm, size 2	14 cm, Blattlänge 55 mm, Fig. 2
042103FX	14 cm, blade length 75 mm, size 3	14 cm, Blattlänge 75 mm, Fig. 3
042104FX	14 cm, blade length 90 mm, size 4	14 cm, Blattlänge 90 mm, Fig. 4

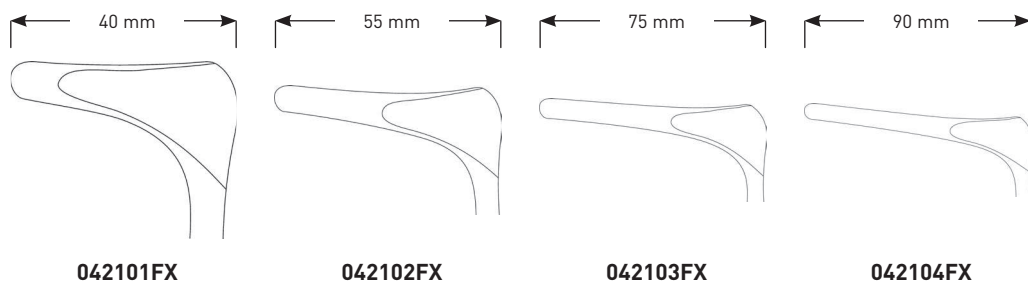



042240FX **Nasal Speculum by Killian-Struycken**, with set screw, 14 cm, blade length 40 mm, size 1
Nasenspekulum nach Killian-Struycken, mit Stellschraube, 14 cm, Blattlänge 40 mm, Fig. 1

042240FX	with set screw / 14 cm, blade length 40 mm, size 1	mit Stellschraube / 14 cm, Blattlänge 40 mm, Fig. 1
042255FX	with set screw / 14 cm, blade length 55 mm, size 2	mit Stellschraube / 14 cm, Blattlänge 55 mm, Fig. 2
042275FX	with set screw / 14 cm, blade length 75 mm, size 3	mit Stellschraube / 14 cm, Blattlänge 75 mm, Fig. 3
042290FX	with set screw / 14 cm, blade length 90 mm, size 4	mit Stellschraube / 14 cm, Blattlänge 90 mm, Fig. 4

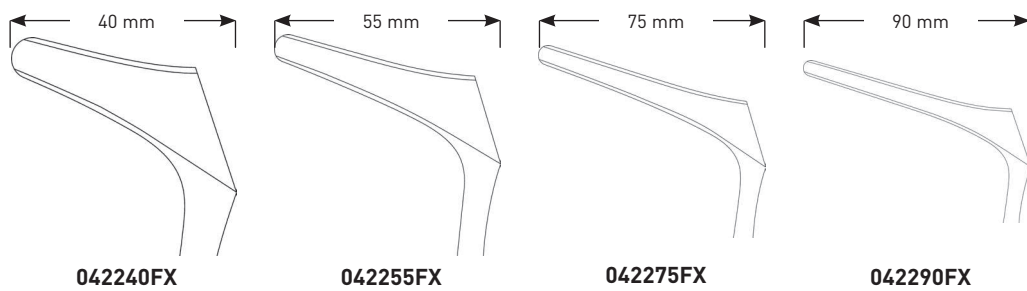



042340FX **Nasal Speculum by Killian-Struycken**, 14 cm, blade length 40 mm, size 1
Nasenspekulum nach Killian-Struycken, 14 cm, Blattlänge 40 mm, Fig. 1

042340FX	14 cm, blade length 40 mm, size 1	14 cm, Blattlänge 40 mm, Fig. 1
042355FX	14 cm, blade length 55 mm, size 2	14 cm, Blattlänge 55 mm, Fig. 2
042375FX	14 cm, blade length 75 mm, size 3	14 cm, Blattlänge 75 mm, Fig. 3
042390FX	14 cm, blade length 90 mm, size 4	14 cm, Blattlänge 90 mm, Fig. 4

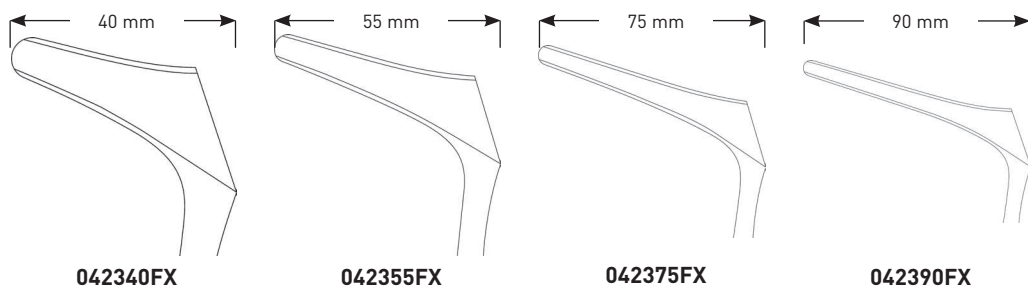



042755FX **Nasal Speculum by Killian**, with light carrier 042700FX, 14 cm, blade length 55 mm, size 2
Nasenspekulum nach Killian, mit Lichtträger 042700FX, 14 cm, Blattlänge 55 mm, Fig. 2

042740FX with light carrier 042700FX / 14 cm, blade length 40 mm, size 1
 mit Lichtträger 042700FX / 14 cm, Blattlänge 40 mm, Fig. 1

042755FX with light carrier 042700FX / 14 cm, blade length 55 mm, size 2
 mit Lichtträger 042700FX / 14 cm, Blattlänge 55 mm, Fig. 2

042775FX with light carrier 042700FX / 14 cm, blade length 75 mm, size 3
 mit Lichtträger 042700FX / 14 cm, Blattlänge 75 mm, Fig. 3

042790FX with light carrier 042700FX / 14 cm, blade length 90 mm, size 4
 mit Lichtträger 042700FX / 14 cm, Blattlänge 90 mm, Fig. 4

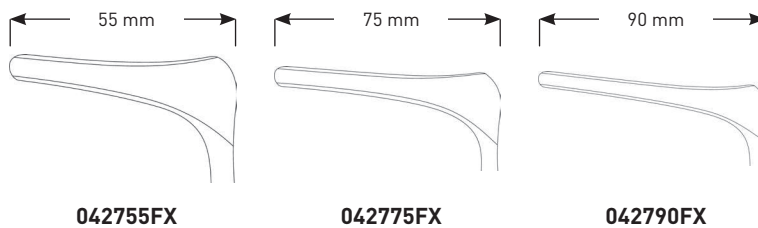

042700FX **Light Carrier**, for 042740FX – 042790FX, Ø 3 mm
Lichtträger, für 042740FX – 042790FX, Ø 3 mm



300101FX **Nasal Speculum by Cottle**, with set screw, 13 cm, size 1, blade length 35 mm
Nasenspekulum nach Cottle, mit Stellschraube, 13 cm, Fig. 1, Blattlänge 35 mm

300101FX	with set screw / 13 cm, size 1, blade length 35 mm	mit Stellschraube / 13 cm, Fig. 1, Blattlänge 35 mm
300102FX	with set screw / 13 cm, size 2, blade length 50 mm	mit Stellschraube / 13 cm, Fig. 2, Blattlänge 50 mm
300103FX	with set screw / 13 cm, size 3, blade length 75 mm	mit Stellschraube / 13 cm, Fig. 3, Blattlänge 75 mm
300104FX	with set screw / 13 cm, size 4, blade length 90 mm	mit Stellschraube / 13 cm, Fig. 4, Blattlänge 90 mm

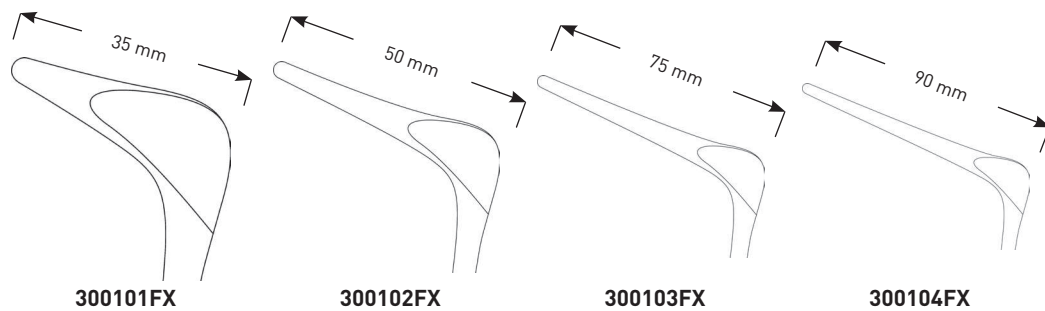



300201FX **Nasal Speculum by Cottle, 13 cm, size 1, blade length 35 mm**
Nasenspekulum nach Cottle, 13 cm, Fig. 1, Blattlänge 35 mm

300201FX	13 cm, size 1, blade length 35 mm	13 cm, Fig. 1, Blattlänge 35 mm
300202FX	13 cm, size 2, blade length 50 mm	13 cm, Fig. 2, Blattlänge 50 mm
300203FX	13 cm, size 3, blade length 75 mm	13 cm, Fig. 3, Blattlänge 75 mm
300204FX	13 cm, size 4, blade length 90 mm	13 cm, Fig. 4, Blattlänge 90 mm

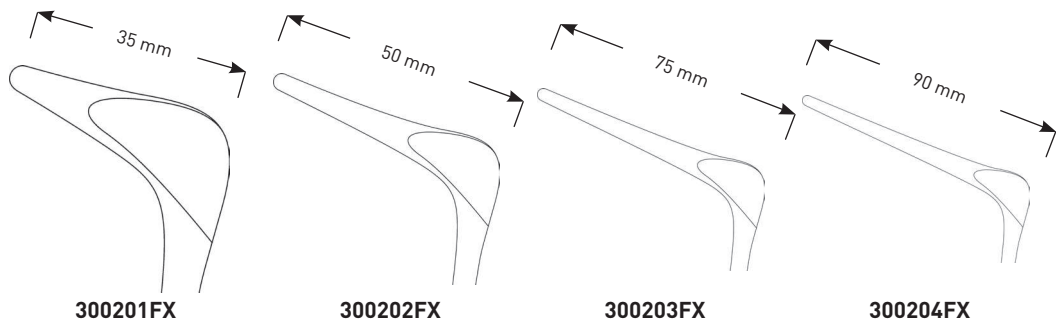



300601FX **Nasal Speculum by Cottle**, black, with set screw, 13 cm, blade length 35 mm
Nasenspekulum nach Cottle, schwarz, mit Stellschraube, 13 cm, Blattlänge 35 mm

300601FX	black, with set screw / 13 cm, blade length 35 mm	schwarz, mit Stellschraube / 13 cm, Blattlänge 35 mm
300603FX	black, with set screw / 13 cm, blade length 50 mm	schwarz, mit Stellschraube / 13 cm, Blattlänge 50 mm
300604FX	black, with set screw / 13 cm, blade length 75 mm	schwarz, mit Stellschraube / 13 cm, Blattlänge 75 mm



300640FX **Nasal Speculum by Killian-Walter**, extra thin blades, with set screw, 14 cm, blade length 40 mm
Nasenspekulum nach Killian-Walter, sehr dünne Blätter, mit Stellschraube, 14 cm, Blattlänge 40 mm

300640FX	extra thin blades, with set screw / 14 cm, blade length 40 mm sehr dünne Blätter, mit Stellschraube / 14 cm, Blattlänge 40 mm
-----------------	----------------------------------------------------------------------------------------------------------------------------------

300655FX	extra thin blades, with set screw / 14 cm, blade length 55 mm sehr dünne Blätter, mit Stellschraube / 14 cm, Blattlänge 55 mm
-----------------	----------------------------------------------------------------------------------------------------------------------------------

300675FX	extra thin blades, with set screw / 14 cm, blade length 75 mm sehr dünne Blätter, mit Stellschraube / 14 cm, Blattlänge 75 mm
-----------------	----------------------------------------------------------------------------------------------------------------------------------

300690FX	extra thin blades, with set screw / 14 cm, blade length 90 mm sehr dünne Blätter, mit Stellschraube / 14 cm, Blattlänge 90 mm
-----------------	----------------------------------------------------------------------------------------------------------------------------------

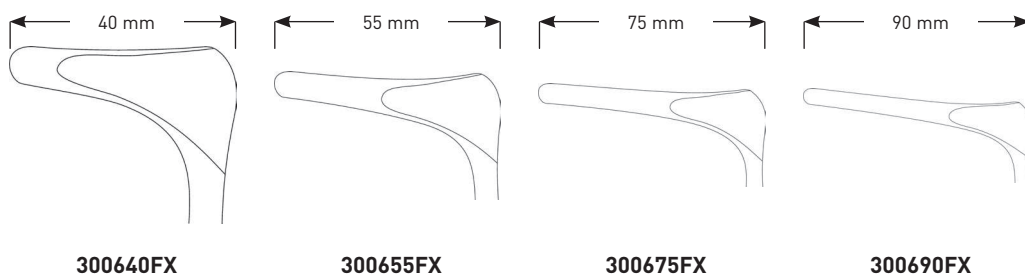



300740FX **Nasal Speculum by Killian**, tapered, with set screw, 14 cm, size 1, blade length 40 mm
Nasenspekulum nach Killian, spitz zulaufend, mit Stellschraube, 14 cm, Fig. 1, Blattlänge 40 mm

300740FX tapered, with set screw / 14 cm, size 1, blade length 40 mm
 spitz zulaufend, mit Stellschraube / 14 cm, Fig. 1, Blattlänge 40 mm

300755FX tapered, with set screw / 14 cm, size 2, blade length 55 mm
 spitz zulaufend, mit Stellschraube / 14 cm, Fig. 2, Blattlänge 55 mm

300775FX tapered, with set screw / 14 cm, size 3, blade length 75 mm
 spitz zulaufend, mit Stellschraube / 14 cm, Fig. 3, Blattlänge 75 mm

300790FX tapered, with set screw / 14 cm, size 4, blade length 90 mm
 spitz zulaufend, mit Stellschraube / 14 cm, Fig. 4, Blattlänge 90 mm

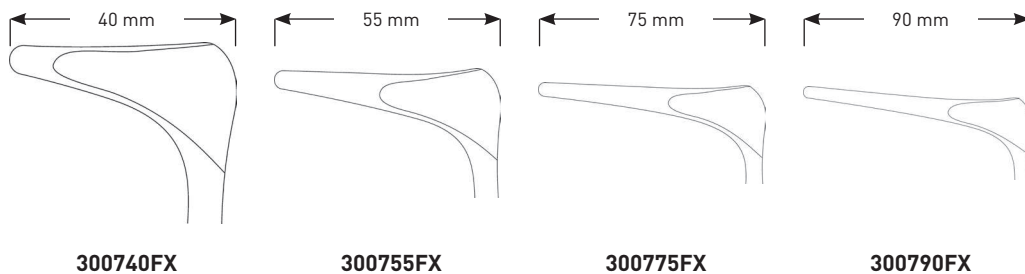



300840FX **Nasal Speculum by Killian**, tapered, 14 cm, size 1, blade length 40 mm
Nasenspekulum nach Killian, spitz zulaufend, 14 cm, Fig. 1, Blattlänge 40 mm

300840FX tapered / 14 cm, size 1, blade length 40 mm
spitz zulaufend / 14 cm, Fig. 1, Blattlänge 40 mm

300855FX tapered / 14 cm, size 2, blade length 55 mm
spitz zulaufend / 14 cm, Fig. 2, Blattlänge 55 mm

300875FX tapered / 14 cm, size 3, blade length 75 mm
spitz zulaufend / 14 cm, Fig. 3, Blattlänge 75 mm

300890FX tapered / 14 cm, size 4, blade length 90 mm
spitz zulaufend / 14 cm, Fig. 4, Blattlänge 90 mm

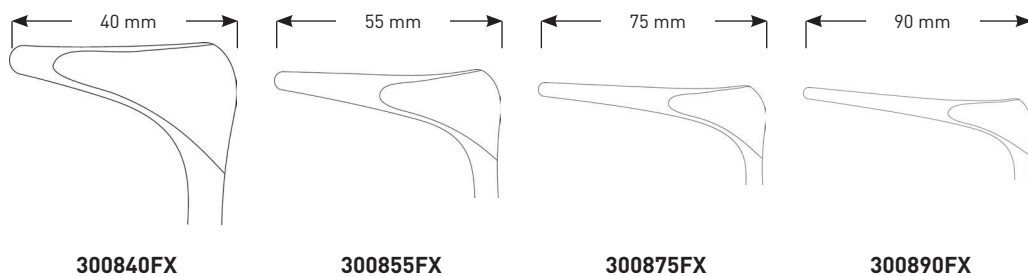



397701FX **Nasal Speculum by Killian**, for 118900FX, right blade shortened, 14 cm, blade length left 55 mm
Nasenspekulum nach Killian, für 118900FX, rechtes Blatt gekürzt, 14 cm, Blattlänge links 55 mm



397702FX **Nasal Speculum by Killian**, for 118900FX, left blade shortened, 14 cm, blade length right 55 mm
Nasenspekulum nach Killian, für 118900FX, linkes Blatt gekürzt, 14 cm, Blattlänge rechts 55 mm



397705FX **Nasal Speculum by Killian**, for 118900FX, right blade shortened, 14 cm, blade length left 75 mm
Nasenspekulum nach Killian, für 118900FX, rechtes Blatt gekürzt, 14 cm, Blattlänge links 75 mm



397706FX **Nasal Speculum by Killian**, for 118900FX, left blade shortened, 14 cm, blade length right 75 mm
Nasenspekulum nach Killian, für 118900FX, linkes Blatt gekürzt, 14 cm, Blattlänge rechts 75 mm



032113FX **Ear Dressing Forceps by Troeltsch**, serrated, 13 cm, WL 7.5 cm
Ohrpinzette nach Troeltsch, gerieft, 13 cm, NL 7,5 cm



032116FX **Ear Dressing Forceps by Troeltsch**, serrated, 16 cm
Ohrpinzette nach Troeltsch, gerieft, 16 cm



032118FX **Ear Dressing Forceps by Troeltsch**, serrated, 18 cm, WL 10 cm
Ohrpinzette nach Troeltsch, gerieft, 18 cm, NL 10 cm



032416FX **Ear Dressing Forceps by Jansen**, bayonet-shaped, 16 cm
Ohrpinzette nach Jansen, bajonettförmig, 16 cm



032419FX **Ear Dressing Forceps by Gruenwald**, bayonet-shaped, 19 cm
Ohrpinzette nach Grünwald, bajonettförmig, 19 cm



045600FX **Choana Hook by Lange**, 23,5 cm
Choanenhaken nach Lange, 23,5 cm



110106FX **Suction Tube by Frazier**, straight tip, with cut-off hole, WL 10 cm, 6 Fr.
Saugrohr nach Frazier, gerades Ende, mit Unterbrecherloch, NL 10 cm, 6 Charr.

110106FX	straight tip, with cut-off hole / WL 10 cm, 6 Fr.	gerades Ende, mit Unterbrecherloch / NL 10 cm, 6 Charr.
110107FX	straight tip, with cut-off hole / WL 10 cm, 7 Fr.	gerades Ende, mit Unterbrecherloch / NL 10 cm, 7 Charr.
110108FX	straight tip, with cut-off hole / WL 10 cm, 8 Fr.	gerades Ende, mit Unterbrecherloch / NL 10 cm, 8 Charr.
110109FX	straight tip, with cut-off hole / WL 10 cm, 9 Fr.	gerades Ende, mit Unterbrecherloch / NL 10 cm, 9 Charr.
110110FX	straight tip, with cut-off hole / WL 10 cm, 10 Fr.	gerades Ende, mit Unterbrecherloch / NL 10 cm, 10 Charr.
110112FX	straight tip, with cut-off hole / WL 10 cm, 12 Fr.	gerades Ende, mit Unterbrecherloch / NL 10 cm, 12 Charr.
110115FX	straight tip, with cut-off hole / WL 10 cm, 15 Fr.	gerades Ende, mit Unterbrecherloch / NL 10 cm, 15 Charr.



250106FX **Suction Tube by Frazier**, straight tip, with cut-off hole, WL 15 cm, 6 Fr.
Saugkanüle nach Frazier, gerades Ende, mit Unterbrecherloch, NL 15 cm, 6 Charr.

250106FX	straight tip, with cut-off hole / WL 15 cm, 6 Fr.	gerades Ende, mit Unterbrecherloch / NL 15 cm, 6 Charr.
250108FX	straight tip, with cut-off hole / WL 15 cm, 8 Fr.	gerades Ende, mit Unterbrecherloch / NL 15 cm, 8 Charr.
250110FX	straight tip, with cut-off hole / WL 15 cm, 10 Fr.	gerades Ende, mit Unterbrecherloch / NL 15 cm, 10 Charr.
250112FX	straight tip, with cut-off hole / WL 15 cm, 12 Fr.	gerades Ende, mit Unterbrecherloch / NL 15 cm, 12 Charr.
250115FX	straight tip, with cut-off hole / WL 15 cm, 15 Fr.	gerades Ende, mit Unterbrecherloch / NL 15 cm, 15 Charr.



110116FX **Suction Tube by Frazier**, ball point tip, with cut-off hole, WL 10 cm, 6 Fr.
Saugrohr nach Frazier, olivenförmiges Ende, mit Unterbrecherloch, NL 10 cm, 6 Charr.

110116FX	ball point tip, with cut-off hole / WL 10 cm, 6 Fr.	olivenförmiges Ende, mit Unterbrecherloch / NL 10 cm, 6 Charr.
110118FX	ball point tip, with cut-off hole / WL 10 cm, 8 Fr.	olivenförmiges Ende, mit Unterbrecherloch / NL 10 cm, 8 Charr.
110120FX	ball point tip, with cut-off hole / WL 10 cm, 10 Fr.	olivenförmiges Ende, mit Unterbrecherloch / NL 10 cm, 10 Charr.
110122FX	ball point tip, with cut-off hole / WL 10 cm, 12 Fr.	olivenförmiges Ende, mit Unterbrecherloch / NL 10 cm, 12 Charr.
110125FX	ball point tip, with cut-off hole / WL 10 cm, 15 Fr.	olivenförmiges Ende, mit Unterbrecherloch / NL 10 cm, 15 Charr.



211616FX **Nasal Cotton Applicator**, round, serrated, 15 cm
Nasenwatteträger, rund, gerieft, 15 cm

211616FX	round, serrated / 15 cm	rund, gerieft / 15 cm
211618FX	round, serrated / 18 cm	rund, gerieft / 18 cm



730116FX **Bipolar Forceps**, straight, with guiding pin, 16 cm, tip 0.5 mm
Bipolare Pinzette, gerade, mit Führungsstift, 16 cm, Spitze 0,5 mm



730116FX **730119FX** **731116FX** **731119FX** **732116FX** **732119FX**

730116FX	straight, with guiding pin / 16 cm, tip 0.5 mm	gerade, mit Führungsstift / 16 cm, Spitze 0,5 mm
730119FX	straight, with guiding pin / 19.5 cm, tip 0.5 mm	gerade, mit Führungsstift / 19,5 cm, Spitze 0,5 mm
731116FX	straight, with guiding pin / 16 cm, tip 1 mm	gerade, mit Führungsstift / 16 cm, Spitze 1 mm
731119FX	straight, with guiding pin / 19.5 cm, tip 1 mm	gerade, mit Führungsstift / 19,5 cm, Spitze 1 mm
732116FX	straight, with guiding pin / 16 cm, tip 2 mm	gerade, mit Führungsstift / 16 cm, Spitze 2 mm
732119FX	straight, with guiding pin / 19.5 cm, tip 2 mm	gerade, mit Führungsstift / 19,5 cm, Spitze 2 mm



741116FX **Bipolar Forceps**, angled, with guiding pin, 16 cm, tip 1 mm
Bipolare Pinzette, abgewinkelt, mit Führungsstift, 16 cm, Spitze 1 mm



741116FX **741119FX** **742116FX** **742119FX**

741116FX	angled, with guiding pin / 16 cm, tip 1 mm	abgewinkelt, mit Führungsstift / 16 cm, Spitze 1 mm
741119FX	angled, with guiding pin / 19.5 cm, tip 1 mm	abgewinkelt, mit Führungsstift / 19,5 cm, Spitze 1 mm
742116FX	angled, with guiding pin / 16 cm, tip 2 mm	abgewinkelt, mit Führungsstift / 16 cm, Spitze 2 mm
742119FX	angled, with guiding pin / 19.5 cm, tip 2 mm	abgewinkelt, mit Führungsstift / 19,5 cm, Spitze 2 mm



761116FX **Bipolar Forceps**, bayonet, with guiding pin, 16.5 cm, straight tip 1 mm
Bipolare Pinzette, bajonett, mit Führungsstift, 16,5 cm, gerade Spitze 1 mm



761116FX

761119FX

762119FX

761116FX	bayonet, with guiding pin / 16.5 cm, straight tip 1 mm	bajonett, mit Führungsstift / 16,5 cm, gerade Spitze 1 mm
761119FX	bayonet, with guiding pin / 19 cm, straight tip 1 mm	bajonett, mit Führungsstift / 19 cm, gerade Spitze 1 mm
762119FX	bayonet, with guiding pin / 19 cm, straight tip 2 mm	bajonett, mit Führungsstift / 19 cm, gerade Spitze 2 mm



750861FX **Bipolar Forceps**, angular, with suction, 19 cm, tip 2 mm
Bipolare Pinzette, kniegebogen, mit Saugung, 19 cm, Spitze 2 mm



726504FX **Bipolar Cable**, for ERBE, Storz, Wolf units, 4,5 m
Bipolares HF Kabel, für ERBE, Storz, Wolf Generatoren, 4,5 m



726506FX **Bipolar Cable**, for US Standard + ERBE ICC units, 4,5 m
Bipolares HF Kabel, für US Standard + ERBE ICC Generatoren, 4,5 m



726508FX **Bipolar Cable**, for Martin, Berchtold, Aesculap units, 4,5 m
Bipolares HF Kabel, für Martin, Berchtold, Aesculap Gen., 4,5 m



726516FX **Bipolar Cable**, for Valleylab, Lamidey, EMC, Bowa units, 4,5 m
Bipolares HF Kabel, für Valleylab, Lamidey, EMC, Bowa Gen., 4,5 m

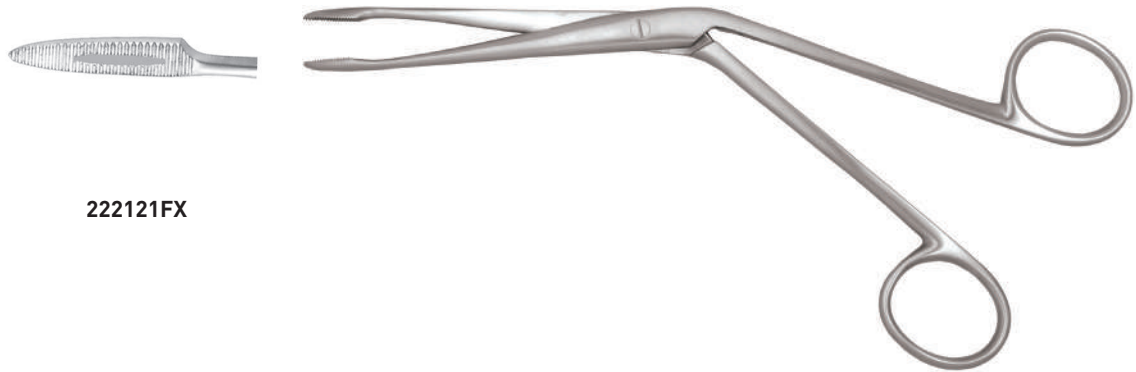

222121FX

222121FX **Nasal Dressing Forceps by Hartmann**, serrated, WL 11 cm
Nasentamponzange nach Hartmann, gerieft, NL 11 cm



222216FX

222216FX **Nasal Dressing Forceps by Hartmann**, delicate, serrated, WL 7.5 cm
Nasentamponzange nach Hartmann, fein, gerieft, NL 7,5 cm



223600FX **Nasal Dressing Forceps by Westmacott**, serrated, 20 cm
Nasentamponzange nach Westmacott, gerieft, 20 cm



224100FX **Nasal Dressing Forceps by Westmacott**, extra delicate, serrated, 20 cm
Nasentamponzange nach Westmacott, extra zart, gerieft, 20 cm



840100FX **Liquid Atomizer**, complete, 30 cc
Flüssigkeitszerstäuber, komplett, 30 ccm



840101FX **Spare Bottle**, brown, for 840100FX, 30 cc
Ersatzflasche, braun, für 840100FX, 30 ccm



840200FX **Liquid Atomizer**, complete (but without rubber bulb)
Flüssigkeitszerstäuber, komplett (aber ohne Gummiball)



840300FX **Rubber Bulb**, for 840100FX
Gummiball, für 840100FX

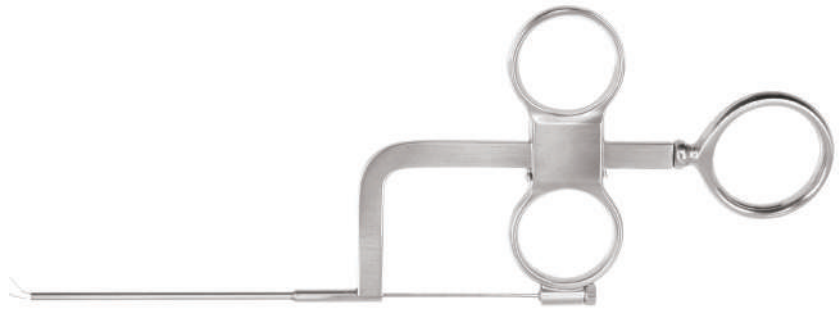

210300FX **Nasal Snare by Lange-Wilde**, bayonet-shaped, 25 cm
Nasenpolypenschnürer nach Lange-Wilde, bajonettförmig, 25 cm



210600FX **Nasal Snare by Krause**, 25 cm
Nasenpolypenschnürer nach Krause, 25 cm



211100FX **Nasal Snare Wire**, for 210300FX + 600FX, pack of 12 pcs., 10 cm, Ø 0.3 mm
Drahtschlinge, für 210300FX + 600FX, Packung zu 12 Stück, 10 cm, Ø 0.3 mm

211100FX for 210300FX + 600FX, pack of 12 pcs. / 10 cm, Ø 0.3 mm
für 210300FX + 600FX, Packung zu 12 Stück / 10 cm, Ø 0.3 mm

211135FX for 210300FX + 600FX, pack of 12 pcs. / 10 cm, Ø 0.35 mm
für 210300FX + 600FX, Packung zu 12 Stück / 10 cm, Ø 0.35 mm

211203FX for 210300FX + 600FX, pack of 100 pcs. / 10 cm, Ø 0.3 mm
für 210300FX + 600FX, Packung zu 100 Stück / 10 cm, Ø 0.3 mm



226300FX

226300FX **Nasal Scissors**, straight, serrated, WL 13 cm
Nasenschere, gerade, gezahnt, NL 13 cm

226300FX straight, serrated / WL 13 cm
gerade, gezahnt / NL 13 cm

226300FXF straight, serrated / WL 13 cm, with flush connector
gerade, gezahnt / NL 13 cm, mit Spülanschluss

226301FX curved left, serrated / WL 13 cm
links gebogen, gezahnt / NL 13 cm

226301FXF curved left, serrated / WL 13 cm, with flush connector
links gebogen, gezahnt / NL 13 cm, mit Spülanschluss

226302FX curved right, serrated / WL 13 cm
rechts gebogen, gezahnt / NL 13 cm

226302FXF curved right, serrated / WL 13 cm, with flush connector
rechts gebogen, gezahnt / NL 13 cm, mit Spülanschluss

226303FX curved up, serrated / WL 13 cm
aufwärts gebogen, gezahnt / NL 13 cm

226304FX curved down, serrated / WL 13 cm
abwärts gebogen, gezahnt / NL 13 cm



226400FX

226400FX **Nasal Scissors**, straight, smooth, WL 11.5 cm
Nasenschere, gerade, glatt, NL 11,5 cm

226400FX	straight, smooth / WL 11.5 cm	gerade, glatt / NL 11,5 cm
226401FX	curved left, smooth / WL 11.5 cm	links gebogen, glatt / NL 11,5 cm
226402FX	curved right, smooth / WL 11.5 cm	rechts gebogen, glatt / NL 11,5 cm



226100FX

226100FX **Nasal Scissors by Heymann**, standard, smooth blades, WL 9.5 cm
Nasenschere nach Heymann, Standard, glatte Schneiden, NL 9,5 cm

226100FX	standard, smooth blades / WL 9.5 cm	Standard, glatte Schneiden / NL 9,5 cm
226109FX	small, smooth blades / WL 9 cm	klein, glatte Schneiden / NL 9 cm
226111FX	large, smooth blades / WL 11 cm	groß, glatte Schneiden / NL 11 cm
226200FX	standard, serrated blades / WL 9.5 cm	Standard, gezahnte Schneiden / NL 9,5 cm
226201FX	small, curved left, smooth blades / WL 9.5 cm	klein, links gebogen, glatte Schneiden / NL 9,5 cm
226202FX	small, curved right, smooth blades / WL 9.5 cm	klein, rechts gebogen, glatte Schneiden / NL 9,5 cm



227600FX



227600FX **Nasal Cutting Forceps by Struycken**, WL 12 cm
Conchotom nach Struycken, NL 12 cm



228100FX **Nasal Cutting Forceps by Schmeden**, through-cutting, WL 12 cm, size 0
Conchotom nach Schmeden, durchschneidend, NL 12 cm, Fig. 0

228100FX	through-cutting / WL 12 cm, size 0	durchschneidend / NL 12 cm, Fig. 0
228101FX	through-cutting / WL 12 cm, size 1	durchschneidend / NL 12 cm, Fig. 1
228102FX	through-cutting / WL 12 cm, size 2	durchschneidend / NL 12 cm, Fig. 2



228100FX



228101FX



228102FX



228601FX **Nasal Cutting Forceps by Gruenwald-Henke**, through-cutting, WL 11 cm, size 1
Conchotom nach Grünwald-Henke, durchschneidend, NL 11 cm, Fig. 1

228601FX	through-cutting / WL 11 cm, size 1	durchschneidend / NL 11 cm, Fig. 1
228602FX	through-cutting / WL 11 cm, size 2	durchschneidend / NL 11 cm, Fig. 2
228603FX	through-cutting / WL 11 cm, size 3	durchschneidend / NL 11 cm, Fig. 3



228601FX



228602FX



228603FX



229101FX

229101FX **Nasal Cutting Forceps by Hartmann**, round, with grid, WL 11 cm, size 1
Conchotom nach Hartmann, rund, mit Fanggitter, NL 11 cm, Fig. 1

229101FX	round, with grid / WL 11 cm, size 1 rund, mit Fanggitter / NL 11 cm, Fig. 1	
229102FX	round, with grid / WL 11 cm, size 2 rund, mit Fanggitter / NL 11 cm, Fig. 2	
229103FX	round, with grid / WL 11 cm, size 3 rund, mit Fanggitter / NL 11 cm, Fig. 3	
229104FX	round, with grid / WL 11 cm, size 4 rund, mit Fanggitter / NL 11 cm, Fig. 4	



227100FX **Nasal Forceps by Takahashi**, straight, WL 12.5 cm, spoon 10 x 2.5 mm
Nasenzange nach Takahashi, gerade, NL 12,5 cm, Löffel 10 x 2,5 mm

227100FX	straight / WL 12.5 cm, spoon 10 x 2.5 mm	gerade / NL 12,5 cm, Löffel 10 x 2,5 mm
227101FX	straight / WL 12.5 cm, spoon 10 x 3 mm	gerade / NL 12,5 cm, Löffel 10 x 3 mm
227102FX	45° upturned / WL 12.5 cm, spoon 10 x 3 mm	45° aufgebogen / NL 12,5 cm, Löffel 10 x 3 mm



227100FX



227101FX



227102FX



230400FX



230400FX **Nasal Forceps by Struempel-Voss**, 45° upturned, extra delicate, WL 12 cm
Nasenzange nach Struempel-Voss, 45° aufgebogen, extra zart, NL 12 cm



230100FX Nasal Forceps by Blakesley, straight, WL 11.5 cm, size 0
Nasenzange nach Blakesley, gerade, NL 11,5 cm, Fig. 0



Pattern Schneide	Size Fig.	0°	45°	90°
	0 = 3,0 mm	230100FX	230200FX	230300FX
	1 = 3,5 mm	230101FX	230201FX	230301FX
	2 = 4,0 mm	230102FX	230202FX	230302FX
	3 = 5,0 mm	230103FX	230203FX	230303FX
	4 = 5,5 mm	230104FX	230204FX	-

230100FX	straight / WL 11.5 cm, size 0	gerade / NL 11,5 cm, Fig. 0
230101FX	straight / WL 11.5 cm, size 1	gerade / NL 11,5 cm, Fig. 1
230102FX	straight / WL 11.5 cm, size 2	gerade / NL 11,5 cm, Fig. 2
230103FX	straight / WL 11.5 cm, size 3	gerade / NL 11,5 cm, Fig. 3
230104FX	straight / WL 11.5 cm, size 4	gerade / NL 11,5 cm, Fig. 4



230200FX	45° upturned / WL 11.5 cm, size 0	45° aufgebogen / NL 11,5 cm, Fig. 0
230201FX	45° upturned / WL 11.5 cm, size 1	45° aufgebogen / NL 11,5 cm, Fig. 1
230202FX	45° upturned / WL 11.5 cm, size 2	45° aufgebogen / NL 11,5 cm, Fig. 2
230203FX	45° upturned / WL 11.5 cm, size 3	45° aufgebogen / NL 11,5 cm, Fig. 3
230204FX	45° upturned / WL 11.5 cm, size 4	45° aufgebogen / NL 11,5 cm, Fig. 4

230300FX	90° upturned / WL 11.5 cm, size 0	90° aufgebogen / NL 11,5 cm, Fig. 0
230301FX	90° upturned / WL 11.5 cm, size 1	90° aufgebogen / NL 11,5 cm, Fig. 1
230302FX	90° upturned / WL 11.5 cm, size 2	90° aufgebogen / NL 11,5 cm, Fig. 2
230303FX	90° upturned / WL 11.5 cm, size 3	90° aufgebogen / NL 11,5 cm, Fig. 3



231601FX **Nasal Forceps by Blakesley**, straight, WL 15 cm, size 1
Nasenzange nach Blakesley, gerade, NL 15 cm, Fig. 1



Pattern Schneide	Size Fig.	0°	45°	90°
	1 = 3,5 mm	231601FX	231701FX	231801FX
	2 = 4,0 mm	231602FX	231702FX	231802FX
	3 = 5,0 mm	231603FX	-	-

231601FX	straight / WL 15 cm, size 1	gerade / NL 15 cm, Fig. 1
231602FX	straight / WL 15 cm, size 2	gerade / NL 15 cm, Fig. 2
231603FX	straight / WL 15 cm, size 3	gerade / NL 15 cm, Fig. 3
231701FX	45° upturned / WL 15 cm, size 1	45° aufgebogen / NL 15 cm, Fig. 1
231702FX	45° upturned / WL 15 cm, size 2	45° aufgebogen / NL 15 cm, Fig. 2
231801FX	90° upturned / WL 15 cm, size 1	90° aufgebogen / NL 15 cm, Fig. 1
231802FX	90° upturned / WL 15 cm, size 2	90° aufgebogen / NL 15 cm, Fig. 2



226901FX



226901FX **Nasal Forceps**, straight, through cutting, small, WL 14 cm
Nasenzange, gerade, durchschneidend, klein, NL 14 cm



226902FX



226902FX **Nasal Forceps**, 45° upturned, through-cutting, small, WL 14 cm
Nasenzange, 45° aufgebogen, durchschneidend, klein, NL 14 cm



226903FX



226903FX **Nasal Forceps**, shaft curved up, through-cutting, small, WL 14 cm
Nasenzange, Schaft aufgebog., durchschneidend, klein, NL 14 cm



226915FX



226915FX

Nasal Forceps, 45° upturned, through-cutting, small, WL 14 cm
Nasenzange, 45° aufgebogen, durchschneidend, klein, NL 14 cm



226904FX



226904FX

Nasal Spoon Forceps, straight, oval cup, WL 14 cm
Nasenlöffelzange, gerade, ovaler Löffel, NL 14 cm



226905FX



226905FX

Nasal Spoon Forceps, 45° upturned, oval cup, WL 14 cm
Nasenlöffelzange, 45° aufgebogen, ovaler Löffel, NL 14 cm

Rhinology
Rhinologie



226906FX



226906FX **Nasal Spoon Forceps**, shaft curved up, oval cup, WL 14 cm
Nasenlöffelzange, Schaft aufgebogen, ovaler Löffel, NL 14 cm



226908FX



226908FX **Nasal Forceps**, shaft curved up, through-cutting, large, WL 14 cm
Nasenzange, Schaft aufgebog., durchschneidend, groß, NL 14 cm



226909FX



226909FX **Nasal Spoon Forceps**, shaft curved up, oval cup, medium, WL 14 cm
Nasenlöffelzange, Schaft aufgebog., ovaler Löffel, mittel, NL 14 cm



226910FX



226910FX **Nasal Forceps**, straight, through-cutting, small, WL 11.5 cm
Nasenzange, gerade, durchschneidend, klein, NL 11,5 cm



226911FX



226911FX **Nasal Forceps**, straight, through-cutting, large, WL 11.5 cm
Nasenzange, gerade, durchschneidend, groß, NL 11,5 cm

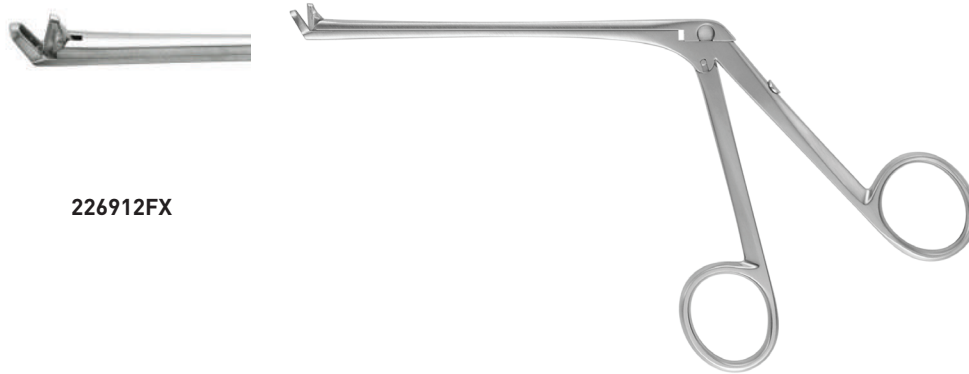

226912FX

226912FX **Nasal Forceps**, 45° upturned, through-cutting, small, WL 11.5 cm
Nasenzange, 45° aufgebogen, durchschneidend, klein, NL 11,5 cm

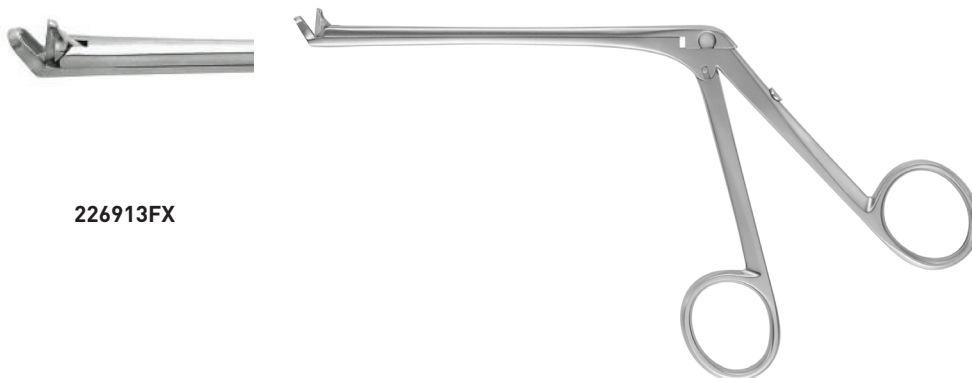

226913FX

226913FX **Nasal Forceps**, 45° upturned, through-cutting, medium, WL 11.5 cm
Nasenzange, 45° aufgebogen, durchschneidend, mittel, NL 11,5 cm



226914FX

226914FX **Nasal Forceps**, 45° upturned, through-cutting, large, WL 11.5 cm
Nasenzange, 45° aufgebogen, durchschneidend, groß, NL 11,5 cm

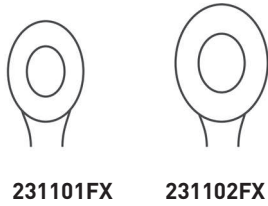

231101FX **Septum Forceps by Luc**, 20.5 cm, size 1
Septumzange nach Luc, 20,5 cm, Fig. 1

231102FX **Septum Forceps by Luc**, 20.5 cm, size 2
Septumzange nach Luc, 20,5 cm, Fig. 2



232101FX **Septum Forceps by Bruenings**, 19 cm, WL 11 cm, size 1
Septumzange nach Bruenings, 19 cm, NL 11 cm, Fig. 1

232101FX	19 cm, WL 11 cm, size 1	19 cm, NL 11 cm, Fig. 1
232102FX	19 cm, WL 11 cm, size 2	19 cm, NL 11 cm, Fig. 2
232103FX	19 cm, WL 11 cm, size 3	19 cm, NL 11 cm, Fig. 3
232104FX	19 cm, WL 11 cm, size 4	19 cm, NL 11 cm, Fig. 4





233100FX **Septum Forceps by Craig**, straight, cupped jaws, sharp, 18 cm, WL 9 cm
Septumzange nach Craig, gerader Löffel, scharf, 18 cm, NL 9 cm

233200FX **Septum Forceps by Craig-Domnick**, curved, cupped jaws, sharp, 18 cm, WL 9 cm
Septumzange nach Craig-Domnick, gebogener Löffel, scharf, 18 cm, NL 9 cm



233100FX



233200FX



233300FX **Septum Forceps by Knight**, 18 cm, WL 10 cm
Septumzange nach Knight, 18 cm, NL 10 cm



235600FX



235600FX **Septum Forceps by Jansen**, with spoon, 18 cm
Septumzange nach Jansen, mit Löffel, 18 cm



235700FX



235700FX **Septum Forceps by Jansen-Middleton**, through-cutting, 19 cm
Septumzange nach Jansen-Middleton, durchschneidend, 19 cm



341600FX **Septum Scissors by Becker**, angled, double-action, 18 cm
Septumschere nach Becker, abgewinkelt, mit Doppelgelenk, 18 cm



342100FX **Septum Morcelizer by Rubin**, double-action, 19 cm
Knorpelquetschzange nach Rubin, mit Doppelgelenk, 19 cm



340100FX **Bone Cutting Forceps by Cottle-Kazanjan**, 18.5 cm
Knochensplitterzange n. Cottle-Kazanjan, 18,5 cm



340600FX **Nasal Scissors by Caplan**, angled, serrated, double-action, 22 cm
Nasenschere nach Caplan, abgewinkelt, gezahnt, mit Doppelgelenk, 22 cm



340800FX **Nasal Hump Rongeur by Rowland**, straight, double-action, 18 cm
Nasenzange nach Rowland, gerade, mit Doppelgelenk, 18 cm



108101FX **Raspatory by Lempert**, slightly curved, 17 cm, width 2 mm
Raspatorium nach Lempert, leicht gebogen, 17 cm, Breite 2 mm

108101FX	slightly curved / 17 cm, width 2 mm	leicht gebogen / 17 cm, Breite 2 mm
108102FX	slightly curved / 17 cm, width 3 mm	leicht gebogen / 17 cm, Breite 3 mm
108103FX	slightly curved / 17 cm, width 4 mm	leicht gebogen / 17 cm, Breite 4 mm
108104FX	slightly curved / 17 cm, width 5 mm	leicht gebogen / 17 cm, Breite 5 mm
108107FX	slightly curved / 17 cm, width 7 mm	leicht gebogen / 17 cm, Breite 7 mm



213100FX **Mucosa Knife by Freer**, 15 cm
Mukosamesser nach Freer, 15 cm



214100FX **Septum Knife by Freer**, 19 cm
Septummesser nach Freer, 19 cm



215100FX **Elevator by Freer**, double-ended, semi-sharp / blunt, 19 cm
Doppelelevatorium nach Freer, halbscharf / stumpf, 19 cm



215200FX **Elevator by Freer**, double-ended, sharp / blunt, 18 cm
Doppelelevatorium nach Freer, scharf / stumpf, 18 cm

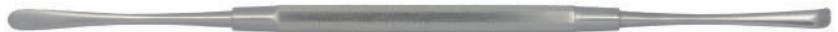

215215FX **Elevator by Weiss**, double-ended, blunt / blunt
Doppelelevatorium nach Weiss, stumpf / stumpf



215300FX **Raspatory by Freer**, curved, 16.5 cm
Raspatorium nach Freer, gebogen, 16,5 cm

Rhinology
Rhinologie



215310FX **Elevator**, angled end, 16.5 cm, width 4 mm
Elevatorium, vorne abgewinkelt, 16,5 cm, Breite 4 mm



215700FX **Elevator by Freer-Joseph**, double-ended, slender, 20 cm
Doppelevatorium nach Freer-Joseph, schlank, 20 cm



216100FX **Elevator by Killian**, double-ended, sharp / blunt, 18 cm
Doppelevatorium nach Killian, scharf / stumpf, 18 cm

216200FX **Elevator by Killian**, double-ended, sharp / blunt, 23 cm
Doppelevatorium nach Killian, scharf / stumpf, 23 cm



216600FX **Raspatory by Cottle**, slightly curved, 20 cm, width 8 mm
Raspatorium nach Cottle, leicht gebogen, 20 cm, Breite 8 mm



219101FX **Swivel Knife by Ballenger**, bayonet-shaped, 19.5 cm, width 3 mm
Schwingmesser nach Ballenger, bajonettförmig, 19,5 cm, Breite 3 mm



219102FX **Swivel Knife by Ballenger**, bayonet-shaped, 19.5 cm, width 4 mm
Schwingmesser nach Ballenger, bajonettförmig, 19,5 cm, Breite 4 mm



220101FX

220101FX **Chisel by Freer**, straight, 18.5 cm, width 4 mm
Flachmeißel nach Freer, gerade, 18,5 cm, Breite 4 mm



220102FX

220102FX **Chisel by Freer**, slightly curved, 18.5 cm, width 4 mm
Flachmeißel nach Freer, leicht gebogen, 18,5 cm, Breite 4 mm



221100FX

221100FX **Septum Gouge by Killian-Claus**, bayonet-shaped, 16.5 cm, width 5 mm
Septummeißel nach Killian-Claus, bajonettförmig, 16,5 cm, Breite 5 mm



221200FX

221200FX **Septum Gouge by Killian-Claus**, bayonet-shaped, V-shaped blade, 16.5 cm, width 5 mm
Septummeißel nach Killian-Claus, bajonettförmig, mit Kerbe, 16,5 cm, Breite 5 mm



302103FX

302103FX **Elevator by McKenty**, 14.5 cm, width 3 mm
Elevatorium nach McKenty, 14,5 cm, Breite 3 mm

302103FX	14.5 cm, width 3 mm	14,5 cm, Breite 3 mm
302104FX	14.5 cm, width 4 mm	14,5 cm, Breite 4 mm
302105FX	14.5 cm, width 5 mm	14,5 cm, Breite 5 mm



302600FX **Elevator by McKenty**, double-ended, 22 cm
Doppelelevatorium nach McKenty, 22 cm



304600FX **Elevator by Cottle**, double-ended, blunt / blunt, graduated, 23 cm
Doppelelevatorium nach Cottle, stumpf / stumpf, graduiert, 23 cm



304900FX **Elevator by Cottle**, double-ended, sharp / blunt, graduated, 20 cm
Doppelelevatorium nach Cottle, scharf / stumpf, graduiert, 20 cm

Rhinology
Rhinologie



305100FX **Elevator by Masing**, double-ended, sharp / blunt, graduated, 21.5 cm
Doppelelevatorium nach Masing, scharf / stumpf, graduiert, 21,5 cm



305600FX **Elevator by Cottle**, double-ended, strong and slight curve, 22.5 cm
Doppelelevatorium nach Cottle, starke und schwache Biegung, 22,5 cm



305700FX **Elevator by Pennington**, double-ended, right and left curve, 20 cm
Doppelelevatorium nach Pennington, rechte und linke Biegung, 20 cm



305900FX **Suction Elevator by Gorney**, with Mandrin, 21.5 cm
Saugelevatorium nach Gorney, mit Mandrin, 21,5 cm



360100FX

360100FX **Suction Elevator by Guillen**, straight tip, 20 cm
Saugelevatorium nach Guillen, Spitze gerade, 20 cm



307104FX

307104FX **Chisel by Cottle**, straight, graduated, 18.5 cm, width 4 mm
Meißel nach Cottle, gerade, graduiert, 18,5 cm, Breite 4 mm

307104FX	straight, graduated / 18.5 cm, width 4 mm	gerade, graduiert / 18,5 cm, Breite 4 mm
307107FX	straight, graduated / 18.5 cm, width 7 mm	gerade, graduiert / 18,5 cm, Breite 7 mm
307109FX	straight, graduated / 18.5 cm, width 9 mm	gerade, graduiert / 18,5 cm, Breite 9 mm
307112FX	straight, graduated / 18.5 cm, width 12 mm	gerade, graduiert / 18,5 cm, Breite 12 mm



307206FX **Chisel by Cottle**, curved, graduated, 18.5 cm, width 6 mm
Meißel nach Cottle, gebogen, graduiert, 18,5 cm, Breite 6 mm



307304FX

307304FX **Osteotome by Cottle**, straight, graduated, 18.5 cm, width 4 mm
Osteotom nach Cottle, gerade, graduiert, 18,5 cm, Breite 4 mm

307304FX	straight, graduated / 18.5 cm, width 4 mm	gerade, graduiert / 18,5 cm, Breite 4 mm
307306FX	straight, graduated / 18.5 cm, width 6 mm	gerade, graduiert / 18,5 cm, Breite 6 mm
307307FX	straight, graduated / 18.5 cm, width 7 mm	gerade, graduiert / 18,5 cm, Breite 7 mm
307309FX	straight, graduated / 18.5 cm, width 9 mm	gerade, graduiert / 18,5 cm, Breite 9 mm
307312FX	straight, graduated / 18.5 cm, width 12 mm	gerade, graduiert / 18,5 cm, Breite 12 mm



307502FX

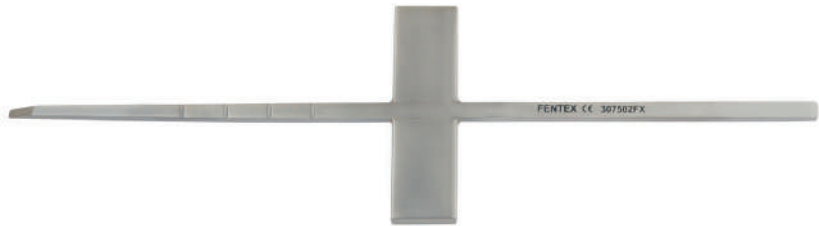

307502FX **Chisel by Cottle**, straight, graduated, with crossbar, 18.5 cm, width 2 mm
Meißel nach Cottle, gerade, graduiert, mit Griffbalken, 18,5 cm, Breite 2 mm

307502FX straight, graduated, with crossbar / 18.5 cm, width 2 mm
gerade, graduiert, mit Griffbalken / 18,5 cm, Breite 2 mm

307504FX straight, graduated, with crossbar / 18.5 cm, width 4 mm
gerade, graduiert, mit Griffbalken / 18,5 cm, Breite 4 mm

307507FX straight, graduated, with crossbar / 18.5 cm, width 7 mm
gerade, graduiert, mit Griffbalken / 18,5 cm, Breite 7 mm

307509FX straight, graduated, with crossbar / 18.5 cm, width 9 mm
gerade, graduiert, mit Griffbalken / 18,5 cm, Breite 9 mm

307512FX straight, graduated, with crossbar / 18.5 cm, width 12 mm
gerade, graduiert, mit Griffbalken / 18,5 cm, Breite 12 mm

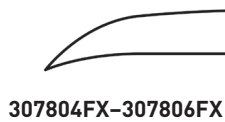

307604FX **Osteotome by Cottle**, straight, graduated, with crossbar, 18.5 cm, width 4 mm
Osteotom nach Cottle, gerade, graduiert, mit Griffbalken, 18,5 cm, Breite 4 mm

307604FX straight, graduated, with crossbar / 18.5 cm, width 4 mm
gerade, graduiert, mit Griffbalken / 18,5 cm, Breite 4 mm

307606FX straight, graduated, with crossbar / 18.5 cm, width 6 mm
gerade, graduiert, mit Griffbalken / 18,5 cm, Breite 6 mm

307804FX curved, graduated, with crossbar / 18.5 cm, width 4 mm
gebogen, graduiert, mit Griffbalken / 18,5 cm, Breite 4 mm

307806FX curved, graduated, with crossbar / 18.5 cm, width 6 mm
gebogen, graduiert, mit Griffbalken / 18,5 cm, Breite 6 mm



310600FX **Osteotome by Cottle**, graduated, single-guarded, 18.5 cm, width 5 mm
Osteotom nach Cottle, einseitiger Schutzdorn, graduiert, 18,5 cm, Breite 5 mm



310605FX **Osteotome by Cottle**, graduated, single-guarded, with crossbar, 18.5 cm, width 5 mm
Osteotom nach Cottle, einseitiger Schutzdorn + Griffbalken, graduiert, 18,5 cm, Breite 5 mm



310610FX **Osteotome by Cottle**, graduated, double-guarded, with crossbar, 18.5 cm, width 10 mm
Osteotom nach Cottle, beidseitiger Schutzdorn + Griffbalken, graduiert, 18,5 cm, Breite 10 mm

310610FX graduated, double-guarded, with crossbar / 18.5 cm, width 10 mm
 beidseitiger Schutzdorn + Griffbalken / graduiert, 18,5 cm, Breite 10 mm

310612FX graduated, double-guarded, with crossbar / 18.5 cm, width 12 mm
 beidseitiger Schutzdorn + Griffbalken / graduiert, 18,5 cm, Breite 12 mm

310614FX graduated, double-guarded, with crossbar / 18.5 cm, width 14 mm
 beidseitiger Schutzdorn + Griffbalken / graduiert, 18,5 cm, Breite 14 mm

310616FX graduated, double-guarded, with crossbar / 18.5 cm, width 16 mm
 beidseitiger Schutzdorn + Griffbalken / graduiert, 18,5 cm, Breite 16 mm



310610FX



310612FX



310614FX

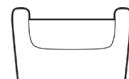

310616FX



306404FX **Chisel by Peck**, 15 cm, width 4 mm
Meißel nach Peck, 15 cm, Breite 4 mm



307702FX **Osteotome by Sheehan**, straight, hexagonal handle, 16 cm, width 2 mm
Osteotom nach Sheehan, gerade, Sechskantgriff, 16 cm, Breite 2 mm

307702FX	straight, hexagonal handle / 16 cm, width 2 mm	gerade, Sechskantgriff / 16 cm, Breite 2 mm
307703FX	straight, hexagonal handle / 16 cm, width 3 mm	gerade, Sechskantgriff / 16 cm, Breite 3 mm
307704FX	straight, hexagonal handle / 16 cm, width 4 mm	gerade, Sechskantgriff / 16 cm, Breite 4 mm
307705FX	straight, hexagonal handle / 16 cm, width 5 mm	gerade, Sechskantgriff / 16 cm, Breite 5 mm
307706FX	straight, hexagonal handle / 16 cm, width 6 mm	gerade, Sechskantgriff / 16 cm, Breite 6 mm
307707FX	straight, hexagonal handle / 16 cm, width 7 mm	gerade, Sechskantgriff / 16 cm, Breite 7 mm
307708FX	straight, hexagonal handle / 16 cm, width 8 mm	gerade, Sechskantgriff / 16 cm, Breite 8 mm
307709FX	straight, hexagonal handle / 16 cm, width 9 mm	gerade, Sechskantgriff / 16 cm, Breite 9 mm
307710FX	straight, hexagonal handle / 16 cm, width 10 mm	gerade, Sechskantgriff / 16 cm, Breite 10 mm
307711FX	straight, hexagonal handle / 16 cm, width 11 mm	gerade, Sechskantgriff / 16 cm, Breite 11 mm
307712FX	straight, hexagonal handle / 16 cm, width 12 mm	gerade, Sechskantgriff / 16 cm, Breite 12 mm



307702FX



307703FX



307704FX



307705FX



307706FX



307707FX



307708FX



307709FX



307710FX



307711FX



307712FX



310800FX **Osteotome „Model Würzburg“**, curved, with double guard, 18 cm, width 3 mm
Osteotom „Würzburger Modell“, gebogen, mit beidseitigem Schutzdorn, 18 cm, Breite 3 mm



310800FX



310801FX



310802FX

310800FX	curved, with double guard / 18 cm, width 3 mm	gebogen, mit beidseitigem Schutzdorn / 18 cm, Breite 3 mm
310801FX	curved, with single guard left / 18 cm, width 3 mm	gebogen, mit Schutzdorn links / 18 cm, Breite 3 mm
310802FX	curved, with single guard right / 18 cm, width 3 mm	gebogen, mit Schutzdorn rechts / 18 cm, Breite 3 mm



307402FX **Mini-Osteotome**, straight, 12.5 cm, width 2 mm
Mini-Osteotom, gerade, 12,5 cm, Breite 2 mm

307402FX	straight / 12.5 cm, width 2 mm	gerade / 12,5 cm, Breite 2 mm
307404FX	straight / 12.5 cm, width 4 mm	gerade / 12,5 cm, Breite 4 mm
307406FX	straight / 12.5 cm, width 6 mm	gerade / 12,5 cm, Breite 6 mm
307408FX	straight / 12.5 cm, width 8 mm	gerade / 12,5 cm, Breite 8 mm
307410FX	straight / 12.5 cm, width 10 mm	gerade / 12,5 cm, Breite 10 mm
307412FX	straight / 12.5 cm, width 12 mm	gerade / 12,5 cm, Breite 12 mm



307402FX



307404FX



307406FX



307408FX



307410FX



307412FX



307422FX **Mini-Osteotome**, curved, 12.5 cm, width 2 mm
Mini-Osteotom, gebogen, 12,5 cm, Breite 2 mm

307422FX	curved / 12.5 cm, width 2 mm	gebogen / 12,5 cm, Breite 2 mm
307424FX	curved / 12.5 cm, width 4 mm	gebogen / 12,5 cm, Breite 4 mm
307426FX	curved / 12.5 cm, width 6 mm	gebogen / 12,5 cm, Breite 6 mm
307428FX	curved / 12.5 cm, width 8 mm	gebogen / 12,5 cm, Breite 8 mm
307430FX	curved / 12.5 cm, width 10 mm	gebogen / 12,5 cm, Breite 10 mm
307432FX	curved / 12.5 cm, width 12 mm	gebogen / 12,5 cm, Breite 12 mm



307422FX



307424FX



307426FX



307428FX

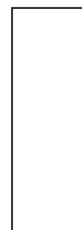

307430FX



307432FX



307902FX **Osteotome by Converse, 18 cm, width 2 mm**
Osteotom nach Converse, 18 cm, Breite 2 mm

307902FX	18 cm, width 2 mm	18 cm, Breite 2 mm
307903FX	18 cm, width 3 mm	18 cm, Breite 3 mm
307904FX	18 cm, width 4 mm	18 cm, Breite 4 mm
307905FX	18 cm, width 5 mm	18 cm, Breite 5 mm
307906FX	18 cm, width 6 mm	18 cm, Breite 6 mm
307907FX	18 cm, width 7 mm	18 cm, Breite 7 mm
307908FX	18 cm, width 8 mm	18 cm, Breite 8 mm
307909FX	18 cm, width 9 mm	18 cm, Breite 9 mm
307910FX	18 cm, width 10 mm	18 cm, Breite 10 mm
307911FX	18 cm, width 11 mm	18 cm, Breite 11 mm
307912FX	18 cm, width 12 mm	18 cm, Breite 12 mm
307914FX	18 cm, width 14 mm	18 cm, Breite 14 mm



307902FX



307903FX



307904FX



307905FX



307906FX



307907FX



307908FX



307909FX



307910FX



307911FX



307912FX

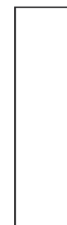

307914FX



308000FX

Chisel by Converse, straight, with single guard, 19 cm, width 5 mm

Meißel nach Converse, gerade, mit einseitigem Schutzdorn, 19 cm, Breite 5 mm



308001FX



308002FX

308000FX	straight, with single guard / 19 cm, width 5 mm	gerade, mit einseitigem Schutzdorn / 19 cm, Breite 5 mm
308001FX	curved left, with single guard / 19 cm, width 5 mm	links geb., mit einseitigem Schutzdorn / 19 cm, Breite 5 mm
308002FX	curved right, with single guard / 19 cm, width 5 mm	rechts geb., mit einseitigem Schutzdorn / 19 cm, Breite 5 mm
308021FX	curved left, with single guard / 19 cm, width 2.2 mm	links geb., mit einseitigem Schutzdorn / 19 cm, Breite 2,2 mm
308022FX	curved right, with single guard / 19 cm, width 2.2 mm	rechts geb., mit einseitigem Schutzdorn / 19 cm, Breite 2,2 mm



306110FX **Osteotome by Rubin**, with finger grip, 16.5 cm, width 10 mm
Osteotom nach Rubin, mit Halteknopf, 16,5 cm, Breite 10 mm

306110FX	with finger grip / 16.5 cm, width 10 mm	mit Halteknopf / 16,5 cm, Breite 10 mm
306112FX	with finger grip / 16.5 cm, width 12 mm	mit Halteknopf / 16,5 cm, Breite 12 mm
306114FX	with finger grip / 16.5 cm, width 14 mm	mit Halteknopf / 16,5 cm, Breite 14 mm
306116FX	with finger grip / 16.5 cm, width 16 mm	mit Halteknopf / 16,5 cm, Breite 16 mm



306110FX

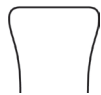

306112FX

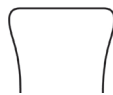

306114FX



306116FX



306200FX

306200FX **Gouge by Rubin**, double-guarded, with finger grip, 16 cm
Hohlmeißel nach Rubin, beidseitiger Schutzdorn, mit Halteknopf, 16 cm



306610FX **Osteotome by Cinelli**, double-guarded, 16 cm, width 10 mm
Osteotom nach Cinelli, beidseitiger Schutzdorn, 16 cm, Breite 10 mm

306610FX	double-guarded / 16 cm, width 10 mm	beidseitiger Schutzdorn / 16 cm, Breite 10 mm
306612FX	double-guarded / 16 cm, width 12 mm	beidseitiger Schutzdorn / 16 cm, Breite 12 mm
306614FX	double-guarded / 16 cm, width 14 mm	beidseitiger Schutzdorn / 16 cm, Breite 14 mm
306616FX	double-guarded / 16 cm, width 16 mm	beidseitiger Schutzdorn / 16 cm, Breite 16 mm



306610FX



306612FX



306614FX

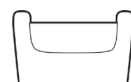

306616FX

Rhinology
Rhinologie



309630FX **Gouge by Walter**, 19 cm, width 3 mm
Hohlmeißel nach Walter, 19 cm, Breite 3 mm

309630FX	19 cm, width 3 mm	19 cm, Breite 3 mm
309645FX	19 cm, width 4.5 mm	19 cm, Breite 4,5 mm



309630FX



309645FX



309702FX **Osteotome by Walter**, 19 cm, width 2 mm
Osteotom nach Walter, 19 cm, Breite 2 mm

309702FX	19 cm, width 2 mm	19 cm, Breite 2 mm
309703FX	19 cm, width 3 mm	19 cm, Breite 3 mm
309704FX	19 cm, width 4 mm	19 cm, Breite 4 mm
309707FX	19 cm, width 7 mm	19 cm, Breite 7 mm
309709FX	19 cm, width 9 mm	19 cm, Breite 9 mm
309712FX	19 cm, width 12 mm	19 cm, Breite 12 mm



309702FX



309703FX



309704FX



309707FX



309709FX



309712FX



310100FX **Chisel by Masing**, straight, with single guard, 18 cm
Meißel nach Masing, gerade, mit einseitigem Schutzdorn, 18 cm



310100FX



310101FX

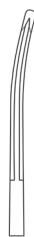

310102FX

310100FX	straight, with single guard / 18 cm	gerade, mit einseitigem Schutzdorn / 18 cm
310101FX	curved left, with single guard / 18 cm	links geb., mit einseitigem Schutzdorn / 18 cm
310102FX	curved right, with single guard / 18 cm	rechts geb., mit einseitigem Schutzdorn / 18 cm



310105FX **Chisel by Masing**, straight, with double guard, 16 cm, width 10 mm
Meißel nach Masing, gerade, mit beidseitigem Schutzdorn, 16 cm, Breite 10 mm



312100FX **Osteotome by Neivert**, straight, 20.5 cm
Osteotom nach Neivert, gerade, 20,5 cm



312101FX



312102FX

312100FX	straight / 20.5 cm	gerade / 20,5 cm
312101FX	curved left / 20.5 cm	links gebogen / 20,5 cm
312102FX	curved right / 20.5 cm	rechts gebogen / 20,5 cm



312600FX **Osteotome by Silver**, straight, with single guard, 18.5 cm
Osteotom nach Silver, gerade, mit einseitigem Schutzdorn, 18,5 cm



312601FX



312602FX

312600FX	straight, with single guard / 18.5 cm	gerade, mit einseitigem Schutzdorn / 18,5 cm
312601FX	curved left, with single guard / 18.5 cm	links geb., mit einseitigem Schutzdorn / 18,5 cm
312602FX	curved right, with single guard / 18.5 cm	rechts geb., mit einseitigem Schutzdorn / 18,5 cm



130100FX **Mallet by Hajek**, steel, solid, 20 cm, 200 g
Hammer nach Hajek, Stahl, massiv, 20 cm, 200 g



313100FX **Mallet by Cottle**, black handle, 18 cm, 335 g
Hammer nach Cottle, schwarzer Griff, 18 cm, 335 g



313600FX **Metal Mallet**, with replaceable nylon facings, 18 cm, 220 g
Metallhammer, mit auswechselbaren Kunststoffbacken, 18 cm, 220 g



313601FX **Spare Nylon Facings**, pair, for mallet 313600FX
Nylon-Ersatzbacken, Paar, für Hammer 313600FX



329500FX **Scalpel Handle by Masing**, 14 cm
Skalpellgriff nach Masing, 14 cm



329103FX **Scalpel Handle**, for Scalpel Blades Fig. 10-15, No. 3
Skalpellgriff, passend für Skalpellklingen Fig. 10-15, Nr. 3



329107FX **Scalpel Handle**, for Scalpel Blades Fig. 10-15, No. 7
Skalpellgriff, passend für Skalpellklingen Fig. 10-15, Nr. 7

329110FX **Scalpel Blades**, sterile, pack of 100 pcs., Fig. 10
Skalpellklingen, steril, Packung zu 100 Stück, Fig. 10

329110FX	sterile, pack of 100 pcs. / Fig. 10	steril, Packung zu 100 Stück / Fig. 10
329111FX	sterile, pack of 100 pcs. / Fig. 11	steril, Packung zu 100 Stück / Fig. 11
329115FX	sterile, pack of 100 pcs. / Fig. 15	steril, Packung zu 100 Stück / Fig. 15



329110FX



329111FX



329115FX

Rhinology
Rhinologie



329410FX **Scalpel Handle**, round, 12.5 cm
Skalpellgriff, rund, 12,5 cm

329430FX **Scalpel Handle**, round, 15 cm
Skalpellgriff, rund, 15 cm

329462FX **Mini Scalpel Blade**, sterile, pack of 25 pcs., Fig. 62
Mini-Skalpellklingen, steril, Packung zu 25 Stück, Fig. 62

329462FX	sterile, pack of 25 pcs. / Fig. 62	steril, Packung zu 25 Stück / Fig. 62
329464FX	sterile, pack of 25 pcs. / Fig. 64	steril, Packung zu 25 Stück / Fig. 64
329465FX	sterile, pack of 25 pcs. / Fig. 65	steril, Packung zu 25 Stück / Fig. 65
329467FX	sterile, pack of 25 pcs. / Fig. 67	steril, Packung zu 25 Stück / Fig. 67



329462FX



329464FX



329465FX



329467FX



303100FX **Nasal Knife by Cottle**, rounded edge, 14 cm
Septummesser nach Cottle, rund, 14 cm



332100FX **Nasal Knife by Masing**, slightly curved, rounded tip, 13.5 cm
Ritzmesser nach Masing, leicht gebogen, abgerundete Spitze, 13,5 cm



334100FX **Rhinoplastic Knife by Joseph**, straight, rounded tip, 15 cm
Nasenplastikmesser nach Joseph, gerade, abgerundete Spitze, 15 cm



335100FX



335300FX

335100FX **Rhinoplastic Knife by Joseph**, straight, sharp, 15 cm
Nasenplastikmesser nach Joseph, gerade, scharf, 15 cm

335300FX **Rhinoplastic Knife by Joseph**, straight, blunt, 15 cm
Nasenplastikmesser nach Joseph, gerade, stumpf, 15 cm



315100FX



315200FX



315100FX **Hook by Cottle**, angled, black finish, 14.5 cm
Häkchen nach Cottle, abgewinkelt, geschwärzt, 14,5 cm

315200FX **Hook by Cottle**, curved, black finish, 14.5 cm
Häkchen nach Cottle, rund gebogen, geschwärzt, 14,5 cm



316100FX **Hook by Cottle**, 2 prongs, right blunt, left sharp, 15 cm, width 10 mm
Häkchen nach Cottle, zweizahnig, rechts stumpf, links scharf, 15 cm, Breite 10mm



316200FX **Hook by Cottle**, 2 prongs, right sharp, left blunt, 15 cm, width 10 mm
Häkchen nach Cottle, zweizahnig, rechts scharf, links stumpf, 15 cm, Breite 10mm



316300FX **Hook by Cottle**, 2 prongs, right sharp, left sharp, 15 cm, width 10 mm
Häkchen nach Cottle, zweizahnig, beidseitig scharf, 15 cm, Breite 10mm



316400FX **Skin Hook by Gillies**, small, sharp, 1 prong, 18 cm
Hauthäkchen nach Gillies, klein, scharf, einzahnig, 18 cm



316500FX **Hook by Freer**, sharp, 2 prongs, 15 cm
Häkchen nach Freer, scharf, zweizahnig, 15 cm



316602FX **Hook by Joseph**, sharp, 2 prongs, 16 cm, width 2 mm
Häkchen nach Joseph, scharf, zweizahnig, 16 cm, Breite 2 mm

316602FX	sharp, 2 prongs / 16 cm, width 2 mm	scharf, zweizahnig / 16 cm, Breite 2 mm
316605FX	sharp, 2 prongs / 16 cm, width 5 mm	scharf, zweizahnig / 16 cm, Breite 5 mm
316607FX	sharp, 2 prongs / 16 cm, width 7 mm	scharf, zweizahnig / 16 cm, Breite 7 mm
316610FX	sharp, 2 prongs / 16 cm, width 10 mm	scharf, zweizahnig / 16 cm, Breite 10 mm
316612FX	sharp, 2 prongs / 16 cm, width 12 mm	scharf, zweizahnig / 16 cm, Breite 12 mm



316602FX



316605FX



316607FX



316610FX



316612FX

Rhinology
Rhinologie



316700FX **Nasal Hook by Fomon**, blunt, 2 prongs, 16.5 cm, width 10 mm
Nasenflügelhaken nach Fomon, stumpf, zweizahnig, 16,5 cm, Breite 10 mm



317100FX

317100FX **Skin Hook by Frazier**, sharp, 1 prong, 12.5 cm
Hauthäkchen nach Frazier, scharf, einzahnig, 12,5 cm



317200FX

317200FX **Hook by Cottle**, sharp, 1 prong, 14.5 cm
Häkchen nach Cottle, scharf, einzahnig, 14,5 cm



318100FX **Retractor by Cottle**, blunt, 4 prongs, 13 cm
Haken nach Cottle, stumpf, vierzahnig, 13 cm



319100FX **Alar Retractor by Cottle**, short blade, 14 cm
Nasenflügelhaken nach Cottle, kurzes Blatt, 14 cm



319600FX **Alar Retractor by Cottle**, with lip, 15 cm
Nasenflügelhaken nach Cottle, mit Lippe, 15 cm



320100FX **Knife Guide/Retractor by Cottle-Neivert**, large, 22 cm
Doppelhaken nach Cottle-Neivert, groß, 22 cm



320101FX **Knife Guide/Retractor by Cottle-Neivert**, small, 19 cm
Doppelhaken nach Cottle-Neivert, klein, 19 cm



320600FX **Knife Guide/Retractor by Neivert**, made of wire, 18 cm
Doppelhaken nach Neivert, aus Draht, 18 cm



464100FX Retractor by Senn-Miller, 3 sharp prongs, 16 cm
Wundhäkchen nach Senn-Miller, 3 scharfe Zähne, 16 cm



464200FX Retractor by Senn-Miller, 3 blunt prongs, 16 cm
Wundhäkchen nach Senn-Miller, 3 stumpfe Zähne, 16 cm



320700FX Nasal Retractor by Walter, double-ended, 12.5 cm
Doppelinstrument nach Walter, 12,5 cm



322600FX **Nasal Retractor by Aufricht**, 17 cm, blade length 60 mm
Nasenrückenhaken nach Aufricht, 17 cm, Blattlänge 60 mm

322700FX **Nasal Retractor by Aufricht**, 16 cm, blade length 45 mm
Nasenrückenhaken nach Aufricht, 16 cm, Blattlänge 45 mm



322900FX **Retractor by Cottle**, with thimble, sharp, 2 prongs, 5.5 cm, width 10 mm
Häkchen nach Cottle, mit Fingerring, scharf, zweizahnig, 5,5 cm, Breite 10 mm



324300FX **Alar Retractor by Converse**, double-ended, blunt / blunt, 2 prongs, 12 cm
Doppel-Nasenflügelhaken nach Converse, stumpf / stumpf, zweizahnig, 12 cm



324400FX **Alar Retractor by Kilner**, sharp, two prongs, 8.5 cm, width 10 mm
Nasenflügelhaken nach Kilner, scharf, zweizahnig, 8,5 cm, Breite 10 mm

324400FX	sharp, two prongs / 8.5 cm, width 10 mm	scharf, zweizahnig / 8,5 cm, Breite 10 mm
324401FX	blunt, two prongs / 8.5 cm, width 10 mm	stumpf, zweizahnig / 8,5 cm, Breite 10 mm
324402FX	sharp, two prongs / 8.5 cm, width 13 mm	scharf, zweizahnig / 8,5 cm, Breite 13 mm

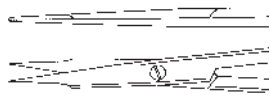

168310FX



168310FX **Scissors by Stevens**, straight, blunt, 10.5 cm
Schere nach Stevens, gerade, stumpf, 10,5 cm

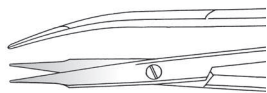

168410FX



168410FX **Scissors by Stevens**, curved, blunt, 10.5 cm
Schere nach Stevens, gebogen, stumpf, 10,5 cm

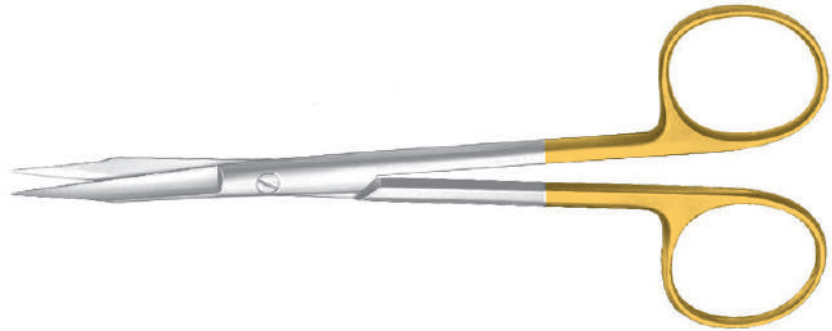

168513FX **Scissors by Goldman-Fox**, straight, bottom blade serrated, with TC, 13 cm
Schere nach Goldman-Fox, gerade, unteres Blatt gezahnt, mit TC, 13 cm

168513FX	straight, bottom blade serrated, with TC / 13 cm	gerade, unteres Blatt gezahnt, mit TC / 13 cm
168713FX	curved, bottom blade serrated, with TC / 13 cm	gebogen, unteres Blatt gezahnt, mit TC / 13 cm
168813FX	curved, Super Cut / 13 cm	gebogen, Super Cut / 13 cm

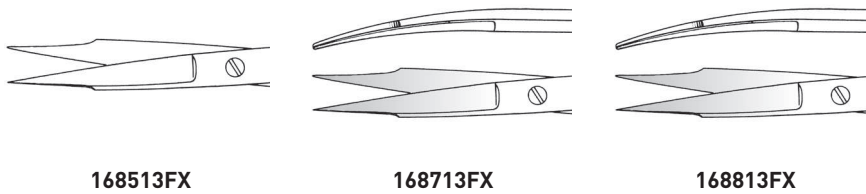

112114FX **Operating Scissors by Mayo**, straight, 14.5 cm
Chirurgische Schere nach Mayo, gerade, 14,5 cm

112114FX	straight / 14.5 cm	gerade / 14,5 cm
112117FX	straight / 17 cm	gerade / 17 cm
112214FX	curved / 14.5 cm	gebogen / 14,5 cm
112217FX	curved / 17 cm	gebogen / 17 cm



176614FX **Scissors by Joseph**, straight, 14 cm
Schere nach Joseph, gerade, 14 cm

176614FX	straight / 14 cm	gerade / 14 cm
176714FX	curved / 14.5 cm	gebogen / 14,5 cm
176814FX	straight, with tungsten carbide inserts / 14.5 cm	gerade, mit Hartmetalleinlagen / 14,5 cm
176914FX	curved, with tungsten carbide inserts / 14.5 cm	gebogen, mit Hartmetalleinlagen / 14,5 cm

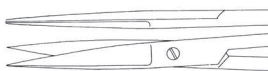

176614FX



176714FX

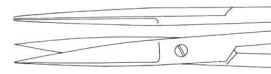

176814FX



176914FX

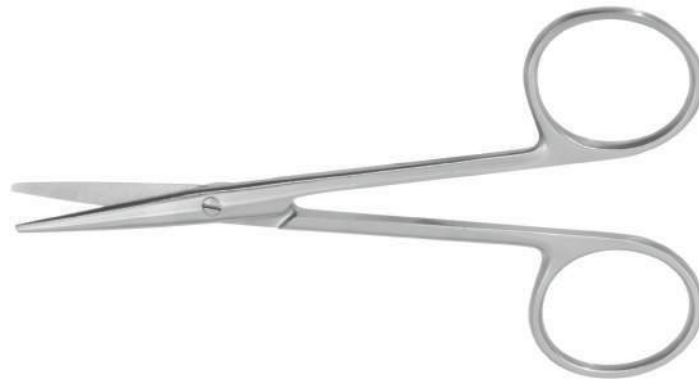

177110FX **Scissors**, straight, bl/bl, 10.5 cm
Schere, gerade, st/st, 10,5 cm

177110FX	straight, bl/bl / 10.5 cm	gerade, st/st / 10,5 cm
177112FX	straight, bl/bl, with TC inserts / 11.5 cm	gerade, st/st, mit Hartmetalleinlagen / 11,5 cm
177210FX	curved, bl/bl / 10.5 cm	gebogen, st/st / 10,5 cm
177212FX	curved, bl/bl, with TC inserts / 11.5 cm	gebogen, st/st, mit Hartmetalleinlagen / 11,5 cm
177312FX	straight, bl/bl / 11.5 cm	gerade, st/st / 11,5 cm
177412FX	curved, bl/bl / 11.5 cm	gebogen, st/st / 11,5 cm



179715FX-179818FX

179715FX **Dissecting Scissors by Reynolds**, curved, 15 cm
Präparierschere nach Reynolds, gebogen, 15 cm

179715FX	curved / 15 cm	gebogen / 15 cm
179718FX	curved / 18 cm	gebogen / 18 cm
179815FX	curved, Super Cut / 15 cm	gebogen, Super Cut / 15 cm
179818FX	curved, Super Cut / 18 cm	gebogen, Super Cut / 18 cm



338812FX-338913FX

338812FX **Scissors by Kilner**, curved, blunt / blunt, 11.5 cm
Schere nach Kilner, gebogen, stumpf / stumpf, 11,5 cm

338812FX	curved, blunt / blunt / 11.5 cm	gebogen, stumpf / stumpf / 11,5 cm
338814FX	curved, blunt / blunt / 14 cm	gebogen, stumpf / stumpf / 14 cm
338913FX	curved, blunt / blunt, with TC / 13,5 cm	gebogen, stumpf / stumpf, mit TC / 13,5 cm

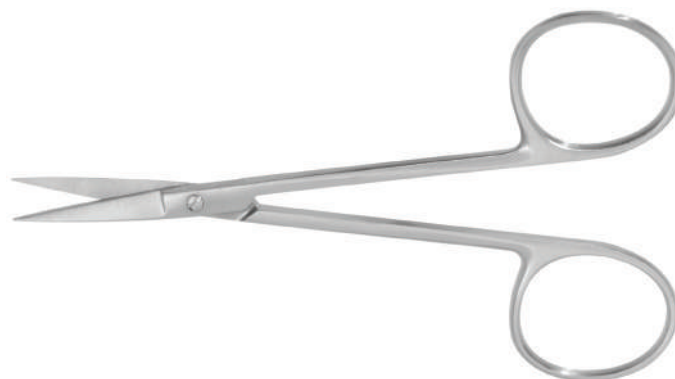

177610FX **Scissors**, straight, sh/sh, 10.5 cm
Schere, gerade, sp/sp, 10,5 cm

177610FX	straight, sh/sh / 10.5 cm	gerade, sp/sp / 10,5 cm
177612FX	straight, sh/sh, with TC inserts / 11.5 cm	gerade, sp/sp, mit Hartmetalleinlagen / 11,5 cm
177621FX	straight, sh/sh, Super Cut / 10.5 cm	gerade, sp/sp, Super Cut / 10,5 cm
177710FX	curved, sh/sh / 10.5 cm	gebogen, sp/sp / 10,5 cm
177712FX	curved, sh/sh, with TC inserts / 11.5 cm	gebogen, sp/sp, mit Hartmetalleinlagen / 11,5 cm
177721FX	curved, sh/sh, Super Cut / 10.5 cm	gebogen, sp/sp, Super Cut / 10,5 cm
177812FX	straight, sh/sh / 11.5 cm	gerade, sp/sp / 11,5 cm
177822FX	straight, sh/sh, Super Cut / 11.5 cm	gerade, sp/sp, Super Cut / 11,5 cm
177912FX	curved, sh/sh / 11.5 cm	gebogen, sp/sp / 11,5 cm
177922FX	curved, sh/sh, Super Cut / 11.5 cm	gebogen, sp/sp, Super Cut / 11,5 cm



442114FX **Dissecting Scissors by Metzenbaum**, curved, blunt / blunt, 14.5 cm
Präparierschere nach Metzenbaum, gebogen, stumpf / stumpf, 14,5 cm

442114FX	curved, blunt / blunt / 14.5 cm	gebogen, stumpf / stumpf / 14,5 cm
442118FX	curved, blunt / blunt / 18 cm	gebogen, stumpf / stumpf / 18 cm
442120FX	curved, blunt / blunt / 20 cm	gebogen, stumpf / stumpf / 20 cm
442314FX	curved, blunt / blunt, with TC / 14.5 cm	gebogen, stumpf / stumpf, mit TC / 14,5 cm
442318FX	curved, blunt / blunt, with TC / 18 cm	gebogen, stumpf / stumpf, mit TC / 18 cm
442320FX	curved, blunt / blunt, with TC / 20 cm	gebogen, stumpf / stumpf, mit TC / 20 cm
442714FX	curved, blunt / blunt, Super Cut / 14.5 cm	gebogen, stumpf / stumpf, Super Cut / 14,5 cm
442718FX	curved, blunt / blunt, Super Cut / 18 cm	gebogen, stumpf / stumpf, Super Cut / 18 cm
442720FX	curved, blunt / blunt, Super Cut / 20 cm	gebogen, stumpf / stumpf, Super Cut / 20 cm



442214FX **Dissecting Scissors by Metzenbaum-Fino**, curved, blunt / blunt, 14.5 cm
Präparierschere nach Metzenbaum-Fino, gebogen, stumpf / stumpf, 14,5 cm

442214FX	curved, blunt / blunt / 14.5 cm	gebogen, stumpf / stumpf / 14,5 cm
442218FX	curved, blunt / blunt / 18 cm	gebogen, stumpf / stumpf / 18 cm
442220FX	curved, blunt / blunt / 20 cm	gebogen, stumpf / stumpf / 20 cm
442514FX	curved, blunt / blunt, with TC / 14.5 cm	gebogen, stumpf / stumpf, mit TC / 14,5 cm
442518FX	curved, blunt / blunt, with TC / 18 cm	gebogen, stumpf / stumpf, mit TC / 18 cm
442814FX	curved, blunt / blunt, Super Cut / 14.5 cm	gebogen, stumpf / stumpf, Super Cut / 14,5 cm
442818FX	curved, blunt / blunt, Super Cut / 18 cm	gebogen, stumpf / stumpf, Super Cut / 18 cm



177510FX **Tenotomy Scissors by Stevens**, straight, sharp, Ergo-Rings, 10 cm
Sehnenscherer nach Stevens, gerade, spitz, Ergo-Ringe, 10 cm



177511FX **Tenotomy Scissors by Stevens**, curved, blunt, Ergo-Rings, 10 cm
Sehnenscherer nach Stevens, gebogen, stumpf, Ergo-Ringe, 10 cm



177521FX **Tenotomy Scissors by Stevens**, curved, blunt, Ergo-Rings, Super Cut, 10 cm
Sehnenscherer nach Stevens, gebogen, stumpf, Ergo-Ringe, Super Cut, 10 cm



338510FX **Scissors by Walter**, angled, 10 cm
Schere nach Walter, abgewinkelt, 10 cm



338612FX

338612FX **Scissors by Fomon**, strongly curved, 13 cm
Schere nach Fomon, stark gebogen, 13 cm



338712FX **Scissors by Fomon**, curved, 12 cm
Schere nach Fomon, gebogen, 12 cm



339100FX **Dorsal Scissors by Fomon**, angular, serrated blades, 13.5 cm
Nasenschere nach Fomon, kniegebogen, gezahnte Schneiden, 13,5 cm



339101FX **Dorsal Scissors by Fomon**, angular, smooth blades, 13.5 cm
Nasenschere nach Fomon, kniegebogen, glatte Schneiden, 13,5 cm



339102FX **Dorsal Scissors by Fomon**, angular, serrated blades, with TC, 13.5 cm
Nasenschere nach Fomon, kniegebogen, gezahnte Schneiden, mit TC, 13,5 cm



339103FX **Dorsal Scissors by Fomon**, angular, Super Cut version, 13.5 cm
Nasenschere nach Fomon, kniegebogen, Super Cut Ausführung, 13,5 cm



339200FX **Dorsal Scissors by Cottle**, angular, smooth blades, 16 cm
Nasenschere nach Cottle, kniegebogen, glatte Schneiden, 16 cm



339300FX **Dorsal Scissors by Cottle**, angular, smooth blades, with TC, 16 cm
Nasenschere nach Cottle, kniegebogen, glatte Schneiden, mit TC, 16 cm



339400FX **Dorsal Scissors by Cottle**, angular, Super Cut version, 16 cm
Nasenschere nach Cottle, kniegebogen, Super Cut Ausführung, 16 cm



301100FX **Columella Forceps by Cottle, 10.5 cm**
Columella Pinzette nach Cottle, 10,5 cm

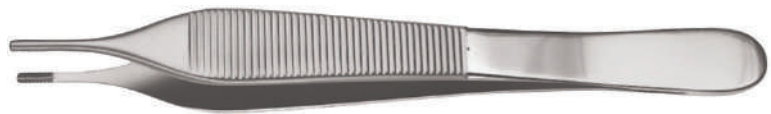

325112FX **Tissue Forceps by Adson-Brown, 12 cm**
Pinzette nach Adson-Brown, 12 cm



325212FX **Dressing Forceps by Adson, 12 cm**
Anatomische Pinzette nach Adson, 12 cm

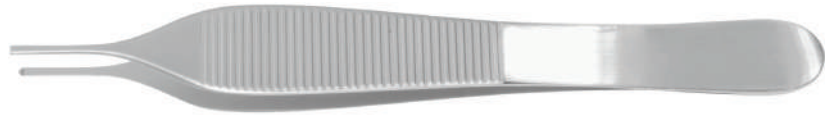

325312FX **Tissue Forceps by Adson, 12 cm, 1 x 2 teeth**
Chirurgische Pinzette nach Adson, 12 cm, 1 x 2 Zähne

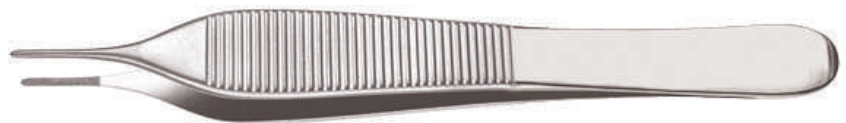

325412FX

325412FX **Dressing Forceps by Micro-Adson, 12 cm**
Anatomische Pinzette nach Mikro-Adson, 12 cm



325512FX

325512FX **Tissue Forceps by Micro-Adson, 12 cm, 1 x 2 teeth**
Chirurgische Pinzette nach Mikro-Adson, 12 cm, 1 x 2 Zähne



326111FX **Fixation Forceps by Graefe**, 11 cm, 7 x 8 prongs
Fixierpinzette nach Graefe, 11 cm, 7 x 8 Zähne



327115FX **Lower Lateral Forceps by Cottle**, bayonet-shaped, serrated, with teeth, 14 cm
Nasenpinzette nach Cottle, bajonettförmig, gerieft, mit Zahnung, 14 cm



328100FX **Cartilage Forceps by Hinderer**, 12.5 cm, 2 x 2 teeth
Nasenpinzette nach Hinderer, 12,5 cm, 2 x 2 Zähne



328110FX **Suture Forceps by Castroviejo**, 10.5 cm, 1 x 2 teeth
Fadenpinzette nach Castroviejo, 10,5 cm, 1 x 2 Zähne



108712FX

108712FX **Dressing Forceps by Semken**, straight, 12.5 cm
Anatomische Pinzette nach Semken, gerade, 12,5 cm



108812FX

108812FX **Tissue Forceps by Semken**, straight, 12.5 cm, 1 x 2 teeth
Chirurgische Pinzette nach Semken, gerade, 12,5 cm, 1 x 2 Zähne



109310FX **Iris Forceps by Graefe**, straight, 10 cm
Irispinzette nach Graefe, gerade, 10 cm

109310FX	straight / 10 cm	gerade / 10 cm
109320FX	curved / 10 cm	gebogen / 10 cm
109410FX	straight / 10 cm, 1 x 2 teeth	gerade / 10 cm, 1 x 2 Zähne
109420FX	curved / 10 cm, 1 x 2 teeth	gebogen / 10 cm, 1 x 2 Zähne



109310FX



109320FX



109410FX



109420FX



109515FX **Tissue Forceps by Gillies**, 15 cm, 1 x 2 teeth
Chirurgische Pinzette nach Gillies, 15 cm, 1 x 2 Zähne

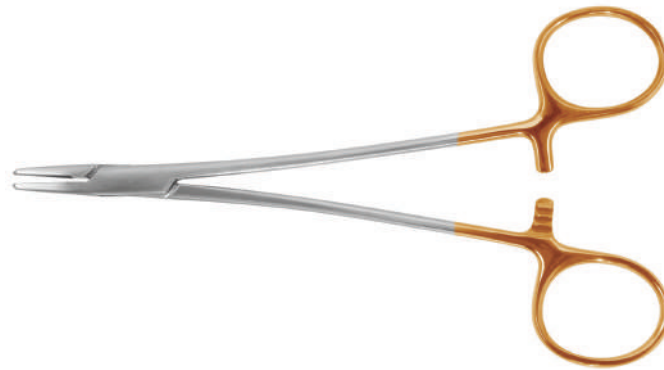

113115FX **Needle Holder by Crile-Wood**, with tungsten carbide inserts, 15 cm
Nadelhalter nach Crile-Wood, mit Hartmetalleinlagen, 15 cm

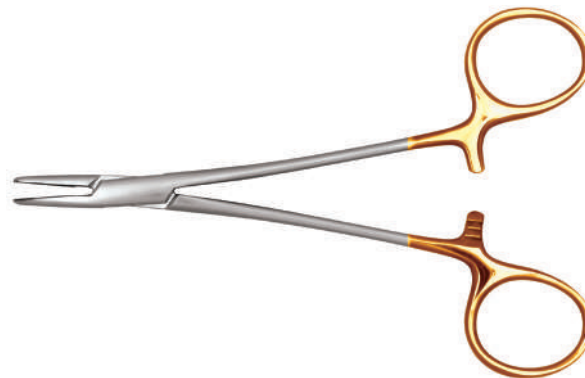

113213FX **Needle Holder by Halsey**, with tungsten carbide inserts, 13.5 cm
Nadelhalter nach Halsey, mit Hartmetalleinlagen, 13,5 cm



365113FX **Needle Holder by Neivert**, thumb ring upturned, 13 cm
Nadelhalter nach Neivert, schräger Daumenring, 13 cm

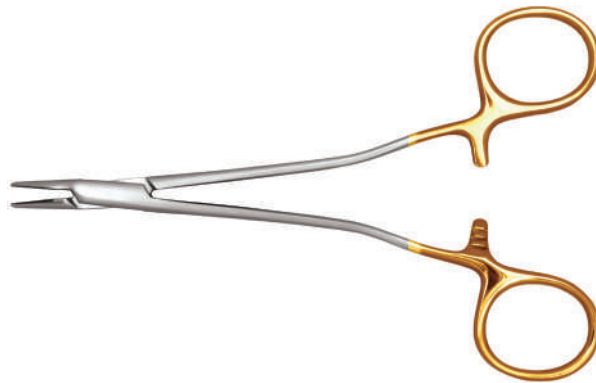

367115FX **Needle Holder by Senning**, with tungsten carbide inserts, 15 cm
Nadelhalter nach Senning, mit Hartmetalleinlagen, 15 cm

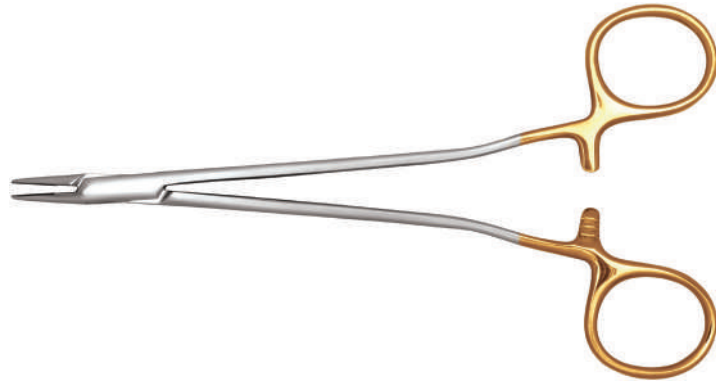

367117FX **Needle Holder by Senning**, with tungsten carbide inserts, 17 cm
Nadelhalter nach Senning, mit Hartmetalleinlagen, 17 cm



368109FX **Needle Holder by Masing-Cottle**, ear forceps shape, smooth jaws, WL 8 cm
Nadelhalter nach Masing-Cottle, Ohrzängchen-Form, glatte Maulteile, NL 8 cm



352101FX **Nasal Rasp**, double-ended, coarse, with TC, 20 cm, size 1 and 2
Knochenraspel, doppelendig, grob, mit TC, 20 cm, Fig. 1 und 2

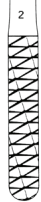

352101FX

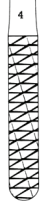
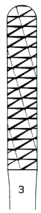

352102FX

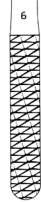
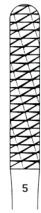

352103FX



352104FX



352105FX

352101FX double-ended, coarse, with TC / 20 cm, size 1 and 2
doppelendig, grob, mit TC / 20 cm, Fig. 1 und 2

352102FX double-ended, coarse and medium, with TC / 20 cm, size 3 and 4
doppelendig, grob und mittel, mit TC / 20 cm, Fig. 3 und 4

352103FX double-ended, medium, with TC / 20 cm, size 5 and 6
doppelendig, mittel, mit TC / 20 cm, Fig. 5 und 6

352104FX double-ended, medium and fine, with TC / 20 cm, size 7 and 8
doppelendig, mittel und fein, mit TC / 20 cm, Fig. 7 und 8

352105FX double-ended, fine, with TC / 20 cm, size 9 and 10
doppelendig, fein, mit TC / 20 cm, Fig. 9 und 10

Rhinology
Rhinologie



353101FX **Nasal Rasp by Parkes**, coarse, with tungsten carbide inserts, 20.5 cm, size 1
Nasenraspel nach Parkes, grob, mit Hartmetalleinlagen, 20,5 cm, Fig. 1

353101FX coarse, with tungsten carbide inserts / 20.5 cm, size 1
grob, mit Hartmetalleinlagen / 20,5 cm, Fig. 1

353102FX coarse, with tungsten carbide inserts / 20.5 cm, size 2
grob, mit Hartmetalleinlagen / 20,5 cm, Fig. 2

353103FX coarse, with tungsten carbide inserts / 20.5 cm, size 3
grob, mit Hartmetalleinlagen / 20,5 cm, Fig. 3

353104FX medium, with tungsten carbide inserts / 20.5 cm, size 4
mittel, mit Hartmetalleinlagen / 20,5 cm, Fig. 4

353105FX medium, with tungsten carbide inserts / 20.5 cm, size 5
mittel, mit Hartmetalleinlagen / 20,5 cm, Fig. 5

353106FX medium, with tungsten carbide inserts / 20.5 cm, size 6
mittel, mit Hartmetalleinlagen / 20,5 cm, Fig. 6

353107FX fine, with tungsten carbide inserts / 20.5 cm, size 7
fein, mit Hartmetalleinlagen / 20,5 cm, Fig. 7

353108FX fine, with tungsten carbide inserts / 20.5 cm, size 8
fein, mit Hartmetalleinlagen / 20,5 cm, Fig. 8



353501FX **Nasal Rasp by Maltz**, coarse, with tungsten carbide inserts, 17 cm, size 1
Nasenraspel nach Maltz, grob, mit Hartmetalleinlagen, 17 cm, Fig. 1

353501FX coarse, with tungsten carbide inserts / 17 cm, size 1 grob, mit Hartmetalleinlagen / 17 cm, Fig. 1

353502FX coarse, with tungsten carbide inserts / 17 cm, size 2 grob, mit Hartmetalleinlagen / 17 cm, Fig. 2

353503FX coarse, with tungsten carbide inserts / 17 cm, size 3 grob, mit Hartmetalleinlagen / 17 cm, Fig. 3

353504FX medium, with tungsten carbide inserts / 17 cm, size 4 mittel, mit Hartmetalleinlagen / 17 cm, Fig. 4

353505FX medium, with tungsten carbide inserts / 17 cm, size 5 mittel, mit Hartmetalleinlagen / 17 cm, Fig. 5

353506FX medium, with tungsten carbide inserts / 17 cm, size 6 mittel, mit Hartmetalleinlagen / 17 cm, Fig. 6

353507FX fine, with tungsten carbide inserts / 17 cm, size 7 fein, mit Hartmetalleinlagen / 17 cm, Fig. 7

353508FX fine, with tungsten carbide inserts / 17 cm, size 8 fein, mit Hartmetalleinlagen / 17 cm, Fig. 8



353600FX **Nasal Rasp by Maltz**, down-cutting, 2 blood grooves, 19 cm
Nasenraspel nach Maltz, auf Zug schneidend, 2 Blutrinnen, 19 cm



353800FX **Nasal Rasp by Maltz**, up-cutting, 2 blood grooves, 19 cm
Nasenraspel nach Maltz, auf Druck schneidend, 2 Blutrinnen, 19 cm



353601FX **Nasal Rasp by Maltz**, down-cutting, 2 blood grooves, TC, 17 cm
Nasenraspel nach Maltz, auf Zug schneidend, 2 Blutrinnen, TC, 17 cm



353602FX **Nasal Rasp by Maltz**, up-cutting, 2 blood grooves, TC, 17 cm
Nasenraspel nach Maltz, auf Druck schneidend, 2 Blutrinnen, TC, 17 cm



353700FX **Nasal Rasp by Maltz**, down-cutting, 2 blood grooves, 19 cm, slender model
Nasenraspel nach Maltz, auf Zug schneidend, 2 Blutrinnen, 19 cm, schlankes Modell

353900FX **Nasal Rasp by Maltz**, up-cutting, 2 blood grooves, 19 cm, slender model
Nasenraspel nach Maltz, auf Druck schneidend, 2 Blutrinnen, 19 cm, schlankes Modell



353603FX **Nasal Rasp by Miller**, double-ended, horizontal serration, TC, 16 cm, No. 1
Nasenraspel nach Miller, doppelendig, quengerieft, TC, 16 cm, Nr. 1

353604FX **Nasal Rasp by Miller**, double-ended, crossed serration, TC, 16 cm, No. 2
Nasenraspel nach Miller, doppelendig, karo-gerieft, TC, 16 cm, Nr. 2



353603FX



353604FX



353620FX **Glabella Nasal Rasp by Aufricht**, with tungsten carbide inserts, 20.5 cm
Glabella Nasenraspel nach Aufricht, mit Hartmetalleinlagen, 20,5 cm



353100FX **Nasal Rasp by Cottle-Masing**, double-ended, fine, 21 cm
Knochenfeile nach Cottle-Masing, doppelendig, fein, 21 cm



353200FX **Nasal Rasp by Cottle-Masing**, double-ended, coarse, 21.5 cm
Knochenfeile nach Cottle-Masing, doppelendig, grob, 21,5 cm



353300FX **Nasal Rasp by Kleinert-Kutz (Fomon)**, double-ended, 22 cm
Nasenraspel nach Kleinert-Kutz (Fomon), doppelendig, 22 cm



354000FX **Nasal Rasp by Joseph**, fine, 17 cm
Nasenraspel nach Joseph, fein, 17 cm



354001FX **Nasal Rasp by Joseph**, coarse, 17 cm
Nasenraspel nach Joseph, grob, 17 cm



354100FX **Nasal Rasp by Cottle**, down-cutting, 21 cm
Nasenraspel nach Cottle, auf Zug schneidend, 21 cm

Rhinology
Rhinologie



354500FX **Glabella Nasal Rasp by Aufricht**, up and down-cutting, 19 cm
Glabella Nasenraspel nach Aufricht, auf Zug und Druck schneidend, 19 cm



354600FX



354700FX

354500FX	up and down-cutting / 19 cm	auf Zug und Druck schneidend / 19 cm
354600FX	down-cutting / 21 cm	auf Zug schneidend / 21 cm
354700FX	up-cutting / 21 cm	auf Druck schneidend / 21 cm



357200FX **Nasal Rasp by Cottle**, with diamond coating, 20.5 cm
Nasenraspel nach Cottle, mit Diamantbeschichtung, 20,5 cm



357300FX **Nasal Rasp by Aufricht**, with diamond coating, 20.5 cm
Nasenraspel nach Aufricht, mit Diamantbeschichtung, 20,5 cm



357401FX **Nasal Rasp**, straight, with diamond coating, 19 cm
Nasenraspel, gerade, mit Diamantbeschichtung, 19 cm



357403FX

357403FX **Nasal Rasp**, curved backward, with diamond coating, 19 cm
Nasenraspel, rückwärts geb., mit Diamantbeschichtung, 19 cm



357500FX **Nasal Rasp by Fomon**, double-ended, with diamond coating, 21 cm
Nasenraspel nach Fomon, doppelendig, mit Diamantbeschichtung, 21 cm



311100FX **Cartilage Insertion Forceps by Cottle**, 15 cm
Knorpel einlegepinzette nach Cottle, 15 cm



348101FX **Nasal Saw by Joseph**, bayonet-shaped, left, 18 cm
Nasensäge nach Joseph, bajonettförmig, links, 18 cm

348101FX	bayonet-shaped, left / 18 cm	bajonettförmig, links / 18 cm
348102FX	bayonet-shaped, right / 18 cm	bajonettförmig, rechts / 18 cm
348200FX	straight / 18 cm	gerade / 18 cm



350100FX **Bone & Cartilage Crusher by Cottle**, with removal clamp
Knorpel-/Knochenquetsche nach Cottle, mit Entnahmeklammer



350700FX **Bone & Cartilage Crusher by Tolsdorff**, to press pieces of bone up to Ø 4 mm
Knorpel-/Knochenquetsche nach Tolsdorff, zum Pressen von Stücken bis zu Ø 4 mm



343100FX **Septum Straightening Forceps by Walsham**, detachable, 21.5 cm
Septumrichtzange nach Walsham, zerlegbar, 21,5 cm



344100FX **Septum Straightening Forceps by Cottle-W**, straight, 23 cm
Septumrichtzange nach Cottle-Walsham, gerade, 23 cm

344100FX	straight / 23 cm	gerade / 23 cm
344201FX	left / 23 cm	links / 23 cm
344202FX	right / 23 cm	rechts / 23 cm



345100FX **Septum Straightening Forceps by Asch**, 22.5 cm
Septumrichtzange nach Asch, 22,5 cm

Rhinology
Rhinologie



360600FX **Nasal Fracture Elevator**, strong pattern, 17 cm
Nasenfraktur Elevatorium, kräftiges Modell, 17 cm



361100FX **Nasal Fracture Elevator by Boies**, 18.5 cm
Nasenfraktur Elevatorium nach Boies, 18,5 cm



361200FX **Nasal Fracture Elevator by Goldman**, 19.5 cm
Nasenfraktur Elevatorium nach Goldman, 19,5 cm



086108FX **Towel Forceps by Backhaus, 8 cm**
Tuchklemme nach Backhaus, 8 cm

086108FX	8 cm	8 cm
086111FX	11 cm	11 cm
086113FX	13 cm	13 cm



222317FX **Nasal Dressing Forceps by Tilley, WL 6.5 cm**
Nasentamponzange nach Tilley, NL 6,5 cm

Rhinology Rhinologie

The NT-Rhinoplasty Set designed by Prof. G. J. Nolst Trenité includes a number of extremely high quality instruments for functional and cosmetic rhinoplasty procedures. The golden Titanium Nitride coating indicates that these German made precision instruments have been carefully designed to help improve the surgical result by reducing postoperative ecchymosis and oedema.

Das NT-Rhinoplastik-Set, entwickelt von Prof. Dr. G. J. Nolst Trenité, besteht aus sehr hochwertigen Instrumenten, die besonders für die delikaten chirurgischen Arbeiten bei funktionalen und kosmetischen Nasenkorrekturen hilfreich sind. Die NT-Instrumente ergänzen das vorhandene Grundsieb, wobei die goldfarbene Titanitritbeschichtung kennzeichnend für die dauerhafte Qualität dieser Produkte ist. Die Operationsergebnisse lassen sich durch den Einsatz hochwertiger Instrumente optimieren (geringere postoperative Einblutungen und reduzierte Narbenbildung).



308500FX **Micro Osteotome**, with guard, Nolst Trenité pattern, 18 cm, width 2.2 mm
Mikro-Osteotom, mit Schutzdorn, Nolst Trenité Modell, 18 cm, Breite 2,2 mm



308501FX **Micro Osteotome**, with guard, Nolst Trenité pattern, 18 cm, width 3 mm
Mikro-Osteotom, mit Schutzdorn, Nolst Trenité Modell, 18 cm, Breite 3 mm



308499FX **Micro Osteotome**, with guard, Nolst Trenité pattern, 18 cm, width 4 mm
Mikro-Osteotom, mit Schutzdorn, Nolst Trenité Modell, 18 cm, Breite 4 mm



308502FX **Micro Osteotome**, Nolst Trenité pattern, 18 cm, width 2 mm
Mikro-Osteotom, Nolst Trenité Modell, 18 cm, Breite 2 mm



308525FX **Micro Osteotome**, Nolst Trenité pattern, 18 cm, width 2.5 mm
Mikro-Osteotom, Nolst Trenité Modell, 18 cm, Breite 2,5 mm



308503FX **Micro Osteotome**, Nolst Trenité pattern, 18 cm, width 3 mm
Mikro-Osteotom, Nolst Trenité Modell, 18 cm, Breite 3 mm



308504FX **Micro Osteotome**, Nolst Trenité pattern, 18 cm, width 4 mm
Mikro-Osteotom, Nolst Trenité Modell, 18 cm, Breite 4 mm



308506FX **Micro Osteotome**, Nolst Trenité pattern, 18 cm, width 6 mm
Mikro-Osteotom, Nolst Trenité Modell, 18 cm, Breite 6 mm

Rhinology
Rhinologie



308510FX **Hump Osteotome**, Nolst Trenité pattern, 18 cm, width 10 mm
Höcker-Osteotom, Nolst Trenité Modell, 18 cm, Breite 10 mm



308512FX **Hump Osteotome**, Nolst Trenité pattern, 18 cm, width 12 mm
Höcker-Osteotom, Nolst Trenité Modell, 18 cm, Breite 12 mm



308514FX **Hump Osteotome**, Nolst Trenité pattern, 18 cm, width 14 mm
Höcker-Osteotom, Nolst Trenité Modell, 18 cm, Breite 14 mm



308516FX **Hump Osteotome**, Nolst Trenité pattern, 18 cm, width 16 mm
Höcker-Osteotom, Nolst Trenité Modell, 18 cm, Breite 16 mm



308518FX **Hump Osteotome**, Nolst Trenité pattern, 18 cm, width 18 mm
Höcker-Osteotom, Nolst Trenité Modell, 18 cm, Breite 18 mm



308523FX **Raspatory by Lempert-Joseph**, Nolst Trenité pattern, 20 cm
Raspatorium nach Lempert-Joseph, Nolst Trenité Modell, 20 cm



308540FX **Glabella Nasal Rasp by Aufricht**, Nolst Trenité pattern, 20 cm
Glabella Nasenraspel nach Aufricht, Nolst Trenité Modell, 20 cm



308560FX **Nasal Retractor by Aufricht**, Nolst Trenité pattern
Nasenrückenhaken nach Aufricht, Nolst Trenité Modell



330101FX **Nasal Forceps by Blakesley**, Nolst Trenité pattern, WL 11 cm
Nasenzange nach Blakesley, Nolst Trenité Modell, NL 11 cm



325612FX **Tissue Forceps by Adson-Brown**, Nolst Trenité pattern, 12 cm
Pinzette nach Adson-Brown, Nolst Trenité Modell, 12 cm



325712FX **Dressing Forceps by Adson**, Nolst Trenité pattern, 12 cm
Anatomische Pinzette nach Adson, Nolst Trenité Modell, 12 cm



325812FX **Tissue Forceps by Adson**, Nolst Trenité pattern, 12 cm, 1 x 2 teeth
Chirurgische Pinzette nach Adson, Nolst Trenité Modell, 12 cm, 1 x 2 Zähne



177615FX **Rhinoplastic Scissors**, straight, sh/sh, Nolst Trenité pattern, 10 cm
Rhinoplastik Schere, gerade, sp/sp, Nolst Trenité Modell, 10 cm



177715FX **Rhinoplastic Scissors**, curved, sh/sh, Nolst Trenité pattern, 10 cm
Rhinoplastik Schere, gebogen, sp/sp, Nolst Trenité Modell, 10 cm



338610FX **Scissors by Walter**, angled, Nolst Trenité pattern, 10 cm
Schere nach Walter, abgewinkelt, Nolst Trenité Modell, 10 cm



338915FX **Scissors by Kilner**, curved, Nolst Trenité pattern, 14 cm
Schere nach Kilner, gebogen, Nolst Trenité Modell, 14 cm



308551FX **Hook**, 1 prong, Nolst Trenité pattern
Häkchen, einzahnig, Nolst Trenité Modell



308552FX **Hook**, 2 prongs, Nolst Trenité pattern, width 2 mm
Häkchen, zweizahnig, Nolst Trenité Modell, Breite 2 mm



308555FX **Hook**, 2 prongs, Nolst Trenité pattern, width 10 mm
Häkchen, zweizahnig, Nolst Trenité Modell, Breite 10 mm

Numerical Index
Numerischer Index

Kat. Nr.	Seite
Cat. No.	Page
032113FX	24
032116FX	24
032118FX	24
032416FX	25
032419FX	25
040100FX	6
040110FX	6
041101FX	6
041102FX	6
041103FX	6
041401FX	7
041402FX	7
041403FX	7
041601FX	8
041602FX	8
041603FX	8
041701FX	9
041702FX	9
041703FX	9
041801FX	10
041802FX	10
041803FX	10
042001FX	12
042002FX	12
042003FX	12
042004FX	12
042101FX	13
042102FX	13
042103FX	13
042104FX	13
042240FX	14
042255FX	14
042275FX	14
042290FX	14
042340FX	15
042355FX	15
042375FX	15
042390FX	15
042700FX	16
042740FX	16
042755FX	16
042775FX	16
042790FX	16
043101FX	11
043102FX	11
045600FX	25
086108FX	118
086111FX	118
086113FX	118
108101FX	53
108102FX	53
108103FX	53
108104FX	53

Kat. Nr.	Seite
Cat. No.	Page
108107FX	53
108712FX	103
108812FX	103
109310FX	104
109320FX	104
109410FX	104
109420FX	104
109515FX	104
110106FX	26
110107FX	26
110108FX	26
110109FX	26
110110FX	26
110112FX	26
110115FX	26
110116FX	27
110118FX	27
110120FX	27
110122FX	27
110125FX	27
112114FX	88
112117FX	88
112214FX	88
112217FX	88
113115FX	105
113213FX	105
130100FX	76
168310FX	87
168410FX	87
168513FX	88
168713FX	88
168813FX	88
176614FX	89
176714FX	89
176814FX	89
176914FX	89
177110FX	90
177112FX	90
177210FX	90
177212FX	90
177312FX	90
177412FX	90
177510FX	95
177511FX	95
177521FX	95
177610FX	92
177612FX	92
177615FX	124
177621FX	92
177710FX	92
177712FX	92
177715FX	124
177721FX	92

Kat. Nr.	Seite
Cat. No.	Page
177812FX	92
177822FX	92
177912FX	92
177922FX	92
179715FX	90
179718FX	90
179815FX	90
179818FX	90
210300FX	34
210600FX	34
211100FX	34
211135FX	34
211203FX	34
211616FX	27
211618FX	27
213100FX	53
214100FX	53
215100FX	54
215200FX	54
215215FX	54
215300FX	54
215310FX	55
215700FX	55
216100FX	55
216200FX	55
216600FX	56
219101FX	56
219102FX	56
220101FX	56
220102FX	57
221100FX	57
221200FX	57
222121FX	31
222216FX	31
222317FX	118
223600FX	31
224100FX	32
226100FX	36
226109FX	36
226111FX	36
226200FX	36
226201FX	36
226202FX	36
226300FX	35
226300FXF	35
226301FX	35
226301FXF	35
226302FX	35
226302FXF	35
226303FX	35
226304FX	35
226400FX	36
226401FX	36

Kat. Nr.	Seite
Cat. No.	Page
226402FX	36
226901FX	43
226902FX	43
226903FX	43
226904FX	44
226905FX	44
226906FX	45
226908FX	45
226909FX	46
226910FX	46
226911FX	46
226912FX	47
226913FX	47
226914FX	47
226915FX	44
227100FX	40
227101FX	40
227102FX	40
227600FX	37
228100FX	37
228101FX	37
228102FX	37
228601FX	38
228602FX	38
228603FX	38
229101FX	39
229102FX	39
229103FX	39
229104FX	39
230100FX	41
230101FX	41
230102FX	41
230103FX	41
230104FX	41
230200FX	41
230201FX	41
230202FX	41
230203FX	41
230204FX	41
230300FX	41
230301FX	41
230302FX	41
230303FX	41
230400FX	40
231101FX	48
231102FX	48
231601FX	42
231602FX	42
231603FX	42
231701FX	42
231702FX	42
231801FX	42
231802FX	42

Numerical Index

Numerischer Index

Kat. Nr. Cat. No.	Seite Page	Kat. Nr. Cat. No.	Seite Page	Kat. Nr. Cat. No.	Seite Page	Kat. Nr. Cat. No.	Seite Page
232101FX	48	306200FX	72	307907FX	69	312100FX	75
232102FX	48	306404FX	65	307908FX	69	312101FX	75
232103FX	48	306610FX	72	307909FX	69	312102FX	75
232104FX	48	306612FX	72	307910FX	69	312600FX	75
233100FX	49	306614FX	72	307911FX	69	312601FX	75
233200FX	49	306616FX	72	307912FX	69	312602FX	75
233300FX	50	307104FX	61	307914FX	69	313100FX	76
235600FX	50	307107FX	61	308000FX	70	313600FX	77
235700FX	50	307109FX	61	308001FX	70	313601FX	77
250106FX	26	307112FX	61	308002FX	70	315100FX	81
250108FX	26	307206FX	61	308021FX	70	315200FX	81
250110FX	26	307304FX	61	308022FX	70	316100FX	81
250112FX	26	307306FX	61	308499FX	119	316200FX	81
250115FX	26	307307FX	61	308500FX	119	316300FX	81
300101FX	17	307309FX	61	308501FX	119	316400FX	82
300102FX	17	307312FX	61	308502FX	120	316500FX	82
300103FX	17	307402FX	67	308503FX	120	316602FX	82
300104FX	17	307404FX	67	308504FX	120	316605FX	82
300201FX	18	307406FX	67	308506FX	120	316607FX	82
300202FX	18	307408FX	67	308510FX	121	316610FX	82
300203FX	18	307410FX	67	308512FX	121	316612FX	82
300204FX	18	307412FX	67	308514FX	121	316700FX	83
300601FX	19	307422FX	68	308516FX	121	317100FX	83
300603FX	19	307424FX	68	308518FX	121	317200FX	83
300604FX	19	307426FX	68	308523FX	122	318100FX	83
300640FX	19	307428FX	68	308525FX	120	319100FX	84
300655FX	19	307430FX	68	308540FX	122	319600FX	84
300675FX	19	307432FX	68	308551FX	125	320100FX	84
300690FX	19	307502FX	62	308552FX	125	320101FX	84
300740FX	20	307504FX	62	308555FX	125	320600FX	84
300755FX	20	307507FX	62	308560FX	122	320700FX	85
300775FX	20	307509FX	62	309630FX	73	322600FX	86
300790FX	20	307512FX	62	309645FX	73	322700FX	86
300840FX	21	307604FX	63	309702FX	73	322900FX	86
300855FX	21	307606FX	63	309703FX	73	324300FX	86
300875FX	21	307702FX	65	309704FX	73	324400FX	87
300890FX	21	307703FX	65	309707FX	73	324401FX	87
301100FX	100	307704FX	65	309709FX	73	324402FX	87
302103FX	58	307705FX	65	309712FX	73	325112FX	100
302104FX	58	307706FX	65	310100FX	74	325212FX	100
302105FX	58	307707FX	65	310101FX	74	325312FX	101
302600FX	58	307708FX	65	310102FX	74	325412FX	101
303100FX	79	307709FX	65	310105FX	74	325512FX	101
304600FX	58	307710FX	65	310600FX	63	325612FX	123
304900FX	58	307711FX	65	310605FX	64	325712FX	123
305100FX	59	307712FX	65	310610FX	64	325812FX	123
305600FX	59	307804FX	63	310612FX	64	326111FX	102
305700FX	59	307806FX	63	310614FX	64	327115FX	102
305900FX	60	307902FX	69	310616FX	64	328100FX	102
306110FX	71	307903FX	69	310800FX	66	328110FX	103
306112FX	71	307904FX	69	310801FX	66	329103FX	78
306114FX	71	307905FX	69	310802FX	66	329107FX	78
306116FX	71	307906FX	69	311100FX	114	329110FX	78

Numerical Index
Numerischer Index

Kat. Nr. Cat. No.	Seite Page
329111FX	78
329115FX	78
329410FX	79
329430FX	79
329462FX	79
329464FX	79
329465FX	79
329467FX	79
329500FX	78
330101FX	123
332100FX	79
334100FX	80
335100FX	80
335300FX	80
338510FX	96
338610FX	124
338612FX	96
338712FX	97
338812FX	91
338814FX	91
338913FX	91
338915FX	125
339100FX	97
339101FX	97
339102FX	98
339103FX	98
339200FX	98
339300FX	99
339400FX	99
340100FX	51
340600FX	52
340800FX	52
341600FX	51
342100FX	51
343100FX	116
344100FX	116
344201FX	116
344202FX	116
345100FX	116
348101FX	115
348102FX	115
348200FX	115
350100FX	115
350700FX	115
352101FX	108
352102FX	108
352103FX	108
352104FX	108
352105FX	108
353100FX	111
353101FX	109
353102FX	109
353103FX	109

Kat. Nr. Cat. No.	Seite Page
353104FX	109
353105FX	109
353106FX	109
353107FX	109
353108FX	109
353200FX	112
353300FX	112
353501FX	109
353502FX	109
353503FX	109
353504FX	109
353505FX	109
353506FX	109
353507FX	109
353508FX	109
353600FX	110
353601FX	110
353602FX	110
353603FX	111
353604FX	111
353620FX	111
353700FX	110
353800FX	110
353900FX	110
354000FX	112
354001FX	112
354100FX	112
354500FX	113
354600FX	113
354700FX	113
357200FX	113
357300FX	113
357401FX	114
357403FX	114
357500FX	114
360100FX	60
360600FX	117
361100FX	117
361200FX	117
365113FX	106
367115FX	106
367117FX	107
368109FX	107
397701FX	22
397702FX	22
397705FX	23
397706FX	23
442114FX	93
442118FX	93
442120FX	93
442214FX	94
442218FX	94
442220FX	94

Kat. Nr. Cat. No.	Seite Page
442314FX	93
442318FX	93
442320FX	93
442514FX	94
442518FX	94
442714FX	93
442718FX	93
442720FX	93
442814FX	94
442818FX	94
464100FX	85
464200FX	85
726504FX	30
726506FX	30
726508FX	30
726516FX	30
730116FX	28
730119FX	28
731116FX	28
731119FX	28
732116FX	28
732119FX	28
741116FX	28
741119FX	28
742116FX	28
742119FX	28
750861FX	29
761116FX	29
761119FX	29
762119FX	29
840100FX	32
840101FX	32
840200FX	33
840300FX	33

Kat. Nr. Cat. No.	Seite Page
------------------------------------	-----------------------------

Author / Description	Page
Alar Retractor by Converse	86
Alar Retractor by Cottle	84
Alar Retractor by Kilner	87
Bipolar Cable	30
Bipolar Forceps.	28, 29
Bone & Cartilage Crusher by Cottle.	115
Bone Cutting Forceps by Cottle-Kazanjan	51
Cartilage Forceps by Hinderer.	102
Cartilage Insertion Forceps by Cottle	114
Chisel by Converse	70
Chisel by Cottle	61, 62
Chisel by Freer	56, 57
Chisel by Masing	74
Chisel by Peck	65
Choana Hook by Lange	25
Columella Forceps by Cottle.	100
Dissecting Scissors by Metzenbaum	93
Dissecting Scissors by Metzenbaum-Fino	94
Dissecting Scissors by Reynolds	90
Dorsal Scissors by Cottle	98, 99
Dorsal Scissors by Fomon	97, 98
Dressing Forceps by Adson	100, 123
Dressing Forceps by Micro-Adson.	101
Dressing Forceps by Semken	103
Ear Dressing Forceps by Gruenwald	25
Ear Dressing Forceps by Troeltsch	24
Elevator	55
Elevator by Cottle	58, 59
Elevator by Freer	54
Elevator by Freer-Joseph	55
Elevator by Masing	59
Elevator by McKenty	58
Elevator by Pennington.	59
Elevator by Weiss.	54
Fixation Forceps by Graefe.	102
Glabella Nasal Rasp by Aufricht.	111, 113, 122
Gouge by Rubin	72
Gouge by Walter	73
Hook	125
Hook by Cottle	81, 83
Hook by Freer	82
Hump Osteotome	121
Iris Forceps by Graefe	104
Knife Guide/Retractor by Cottle-Neivert	84
Light Carrier	16
Liquid Atomizer.	32, 33
Lower Lateral Forceps by Cottle	102
Mallet by Cottle	76
Metal Mallet.	77
Micro Osteotome	119, 120
Mini Scalpel Blade	79
Mini-Osteotome.	67, 68
Mucosa Knife by Freer	53
Nasal Cotton Applicator	27
Nasal Cutting Forceps by Gruenwald-Henke.	38
Nasal Cutting Forceps by Hartmann	39
Nasal Cutting Forceps by Schmeden	37
Nasal Dressing Forceps by Hartmann	31

Author / Description	Page
Nasal Dressing Forceps by Tilley	118
Nasal Dressing Forceps by Westmacott	31, 32
Nasal Forceps.	43, 44, 45, 46, 47
Nasal Forceps by Blakesley	41, 42, 123
Nasal Forceps by Blakesley-Wilde	41
Nasal Forceps by Struempel-Voss	40
Nasal Fracture Elevator	117
Nasal Hook by Fomon	83
Nasal Hump Rongeur by Rowland.	52
Nasal Knife by Cottle	79
Nasal Rasp	108, 114
Nasal Rasp by Aufricht.	113
Nasal Rasp by Cottle	112, 113
Nasal Rasp by Cottle-Masing	111, 112
Nasal Rasp by Fomon	114
Nasal Rasp by Joseph	112
Nasal Rasp by Maltz	109, 110
Nasal Rasp by Miller	111
Nasal Rasp by Parkes	109
Nasal Retractor by Aufricht	86, 122
Nasal Retractor by Walter	85
Nasal Saw by Joseph.	115
Nasal Scissors	35, 36
Nasal Scissors by Caplan	52
Nasal Scissors by Heymann	36
Nasal Snare by Krause.	34
Nasal Speculum by Beckmann	10
Nasal Speculum by Cottle	17, 18, 19
Nasal Speculum by Hartmann.	8, 11
Nasal Speculum by Hartmann-Halle	6
Nasal Speculum by Killian.	12, 13, 16, 20, 21, 22, 23
Nasal Speculum by Killian-Struycken	14, 15
Nasal Speculum by Killian-Walter	19
Nasal Speculum by Thudichum	7
Nasal Speculum by Tieck-Halle	6
Nasal Speculum Model Vienna	9
Nasal Spoon Forceps.	44, 45, 46
Needle Holder by Crile-Wood	105
Needle Holder by Masing-Cottle	107
Needle Holder by Neivert	106
Needle Holder by Senning	107
Operating Scissors by Mayo	88
Osteotome "Model Würzburg".	66
Osteotome by Cinelli	72
Osteotome by Converse	69
Osteotome by Cottle	61, 63, 64
Osteotome by Neivert	75
Osteotome by Rubin	71
Osteotome by Sheehan.	65
Osteotome by Silver	75
Osteotome by Walter	73
Raspatory by Cottle.	56
Raspatory by Freer	54
Raspatory by Lempert	53
Raspatory by Lempert-Joseph	122
Retractor by Cottle	83, 86
Retractor by Senn-Miller.	85
Rhinoplastic Knife by Joseph	80

Author / Description	Page
Rhinoplastic Scissors	124
Rubber Bulb.	33
Scalpel Blades	78
Scalpel Handle	79
Scalpel Handle by Masing	78
Scissors	90, 92
Scissors by Fomon	96, 97
Scissors by Goldman-Fox	88
Scissors by Joseph	89
Scissors by Kilner	91, 125
Scissors by Stevens.	87
Scissors by Walter	96, 124
Septum Forceps by Bruenings.	48
Septum Forceps by Craig	49
Septum Forceps by Jansen	50
Septum Forceps by Luc	48
Septum Gouge by Killian-Claus	57
Septum Knife by Freer	53
Septum Morcelizer by Rubin.	51
Septum Straightening Forceps by Asch.	116
Skin Hook by Frazier	83
Skin Hook by Gillies	82
Spare Bottle.	32
Spare Nylon Facings	77
Suction Elevator by Gorney	60
Suction Tube by Frazier	26, 27
Suture Forceps by Castroviejo.	103
Swivel Knife by Ballenger	56
Tenotomy Scissors by Stevens.	95
Tissue Forceps by Adson.	101, 123
Tissue Forceps by Adson-Brown	100, 123
Tissue Forceps by Gillies.	104
Tissue Forceps by Micro-Adson	101
Tissue Forceps by Semken.	103
Towel Forceps by Backhaus	118

Author / Description	Page
----------------------	------

Autor / Beschreibung	Seite
Anatomische Pinzette nach Adson	100, 123
Anatomische Pinzette nach Mikro-Adson	101
Anatomische Pinzette nach Semken	103
Bipolare Pinzette	28, 29
Bipolares HF Kabel	30
Chirurgische Pinzette nach Adson	101, 123
Chirurgische Pinzette nach Gillies	104
Chirurgische Pinzette nach Mikro-Adson.	101
Chirurgische Pinzette nach Semken	103
Chirurgische Schere nach Mayo.	88
Choanenhaken nach Lange	25
Columella Pinzette nach Cottle	100
Conchotom nach Grünwald-Henke	38
Conchotom nach Hartmann	39
Conchotom nach Schmeden	37
Doppel-Nasenflügelhaken nach Converse	86
Doppelevatorium nach Cottle	58, 59
Doppelevatorium nach Freer	54
Doppelevatorium nach Freer-Joseph.	55
Doppelevatorium nach Masing	59
Doppelevatorium nach McKenty.	58
Doppelevatorium nach Pennington	59
Doppelevatorium nach Weiss	54
Doppelhaken nach Cottle-Neivert.	84
Doppelinstrument nach Walter	85
Drahtschlinge.	34
Elevatorium	55
Elevatorium nach McKenty	58
Ersatzflasche	32
Fadenpinzette nach Castroviejo	103
Fixierpinzette nach Graefe.	102
Flachmeißel nach Freer	56, 57
Flüssigkeitszerstäuber.	32, 33
Glabella Nasenraspel nach Aufricht	111, 113, 122
Gummiball	33
Häkchen	125
Häkchen nach Cottle	81, 83, 86
Häkchen nach Freer	82
Haken nach Cottle	83
Hammer nach Cottle	76
Hauthäkchen nach Frazier.	83
Hauthäkchen nach Gillies	82
Höcker-Osteotom.	121
Hohlmeißel nach Rubin	72
Hohlmeißel nach Walter	73
Irispinzette nach Graefe	104
Knochenfeile nach Cottle-Masing.	111, 112
Knochenraspel	108
Knochensplitterzange n. Cottle-Kazanjan	51
Knorpel-/Knochenquetsche nach Cottle	115
Knorpel einlegepinzette nach Cottle.	114
Knorpelquetschzange nach Rubin	51
Lichtträger	16
Meißel nach Converse	70
Meißel nach Cottle	61, 62
Meißel nach Masing	74
Meißel nach Peck.	65
Metallhammer	77

Autor / Beschreibung	Seite
Mikro-Osteotom	119, 120
Mini-Osteotom	67, 68
Mini-Skalpellklingen	79
Mukosamesser nach Freer	53
Nadelhalter nach Crile-Wood	105
Nadelhalter nach Masing-Cottle	107
Nadelhalter nach Neivert	106
Nadelhalter nach Senning	107
Nasenflügelhaken nach Cottle	84
Nasenflügelhaken nach Fomon	83
Nasenflügelhaken nach Kilner	87
Nasenfraktur Elevatorium	117
Nasenlöfflzange	44, 45, 46
Nasenpinzette nach Cottle.	102
Nasenplastikmesser nach Joseph	80
Nasenpolypenschnürer nach Krause	34
Nasenraspel	114
Nasenraspel nach Aufricht	113
Nasenraspel nach Cottle.	112, 113
Nasenraspel nach Fomon	114
Nasenraspel nach Joseph	112
Nasenraspel nach Maltz	109, 110
Nasenraspel nach Miller.	111
Nasenraspel nach Parkes	109
Nasentrückerhaken nach Aufricht.	86, 122
Nasensäge nach Joseph	115
Nasenschere	35, 36
Nasenschere nach Caplan	52
Nasenschere nach Cottle	98, 99
Nasenschere nach Fomon	97, 98
Nasenschere nach Heymann	36
Nasenspekulum Modell Wien	9
Nasenspekulum nach Beckmann	10
Nasenspekulum nach Cottle.	17, 18, 19
Nasenspekulum nach Hartmann	8, 11
Nasenspekulum nach Hartmann-Halle.	6
Nasenspekulum nach Killian	12, 13, 16, 20, 21, 22, 23
Nasenspekulum nach Killian-Struycken	14, 15
Nasenspekulum nach Killian-Walter	19
Nasenspekulum nach Thudichum.	7
Nasenspekulum nach Tieck-Halle	6
Nasentamponzange nach Hartmann	31
Nasentamponzange nach Tilley	118
Nasentamponzange nach Westmacott	31, 32
Nasenwatteträger	27
Nasenzange	43, 44, 45, 46, 47
Nasenzange nach Blakesley.	41, 42, 123
Nasenzange nach Blakesley-Wilde	41
Nasenzange nach Rowland	52
Nasenzange nach Struempel-Voss	40
Nylon-Ersatzbacken	77
Ohrpinzette nach Grünwald	25
Ohrpinzette nach Troeltsch	24
Osteotom „Würzburger Modell“	66
Osteotom nach Cinelli	72
Osteotom nach Converse	69
Osteotom nach Cottle	61, 63, 64
Osteotom nach Neivert.	75

Autor / Beschreibung	Seite
Osteotom nach Rubin	71
Osteotom nach Sheehan	65
Osteotom nach Silver	75
Osteotom nach Walter	73
Pinzette nach Adson-Brown	100, 123
Präparierschere nach Metzenbaum	93
Präparierschere nach Metzenbaum-Fino	94
Präparierschere nach Reynolds	90
Raspatorium nach Cottle	56
Raspatorium nach Freer	54
Raspatorium nach Lempert	53
Raspatorium nach Lempert-Joseph	122
Rhinoplastik Schere	124
Ritzmesser nach Masing	79
Saugelevatorium nach Gorney	60
Saugkanüle nach Frazier	26
Saugrohr nach Frazier	27
Schere	90, 92
Schere nach Fomon	96, 97
Schere nach Goldman-Fox	88
Schere nach Joseph	89
Schere nach Kilner	91, 125
Schere nach Stevens	87
Schere nach Walter	96, 124
Schwingmesser nach Ballenger	56
Sehnenschere nach Stevens	95
Septummeißel nach Killian-Claus	57
Septummesser nach Cottle	79
Septummesser nach Freer	53
Septumrichtzange nach Asch	116
Septumschere nach Becker	51
Septumzange nach Bruenings	48
Septumzange nach Craig	49
Septumzange nach Jansen	50
Septumzange nach Luc	48
Skalpellgriff	78, 79
Skalpellgriff nach Masing	78
Tuchklemme nach Backhaus	118
Wundhäkchen nach Senn-Miller	85

Autor / Beschreibung	Seite
----------------------	-------

FENTEXmedical GmbH

take-off GewerbePark 2
D-78579 Neuhausen ob Eck

Tel. +49 (0) 7467 - 949 62 0
Fax +49 (0) 7467 - 949 62 17
info@fentexmedical.com
www.fentexmedical.com

FENTEX Instruments · *Made in Germany*

© FENTEXmedical GmbH · 2026 · Art.-Nr 002FX

